

Supplemento

– AI CATALOGHI UTENSILI DI TORNITURA E UTENSILI ROTANTI



TOOLSERVICE Sas
di F. VALENZA & C.

Via Florio, 130 - 90146 Palermo

Tel. 091 6887546

☎ 340 6056613 ☎ 351 8105238

commerciale@toolservicepa.it - www.toolservicepa.it

Seguici su



Rivenditore autorizzato:



PRECITOOL®
SEMPRE LA GIUSTA SOLUZIONE

Mitutoyo

Blaser.
SWISSLUBE

UFS

LISTA



Tornitura generale	A
Fresatura	B
Foratura	C
Barenatura	D
Adattatori per utensili rotanti	E
Informazioni generali	F

Tornitura generale

CoroTurn® Prime

Inseri A2

CoroTurn® TR

Inseri A3

CoroTurn® 107

Inseri A5-A8
Utensili per esterni A10-A13
Utensili per interni A14

T-Max® P

Inseri A15-A23

T-Max®

Inseri A24

CoroTurn® XS

Utensili da taglio A25

Dati di taglio

A26

Per informazioni sulla gamma completa, visitare il sito www.sandvik.coromant.com/it

A
B
C
D
E
F

TORNITURA GENERALE Inserti

CoroTurn® Prime, inserto per tornitura

Inserto di tipo A

Finitura	SSC	S	REEQ	RE	CODICE ISO	P	
						4415	4425
L5	CP-A	6.00	0.4	0.40	CP-A1104-L5	★	☆
		.236	.016	.016			
		6.00	0.8	0.79	CP-A1108-L5	★	☆
		.236	.031	.031			
L3W	CP-A	6.00	0.8	0.80	CP-A1108-L5W	★	☆
		.236	.031	.031			
L3	CP-A	6.00		0.79	CP-A1108-L3	★	☆
		.236		.031			
L3WX	CP-A	6.00	0.8	0.80	CP-A1108-L3WX	★	☆
		.236	.031	.031			

Inserto di tipo B

Finitura	SSC	S	REEQ	RE	CODICE ISO	P	
						4425	
L4	CP-B	5.00	0.8	0.80	CP-B1108-L4	★	
		.197	.031	.031			
L4W	CP-B	5.00	0.8	0.80	CP-B1108-L4W	★	
		.197	.031	.031			
M5	CP-B	5.00	0.8	0.80	CP-B1108-M5	★	
		.197	.031	.031			
M5W	CP-B	5.00	0.8	0.80	CP-B1108-M5W	★	
		.197	.031	.031			
H3W	CP-B	5.00	0.8	0.80	CP-B1108-H3W	★	
		.197	.031	.031			
H3	CP-B	5.00	0.8	0.80	CP-B1108-H3	★	
		.197	.031	.031			

SSC = Deve corrispondere al codice di misura SSC sull'utensile.

A26

F2

A 2

CoroTurn® TR, inserto per tornitura

Inserto di tipo D (romboidale 55°)

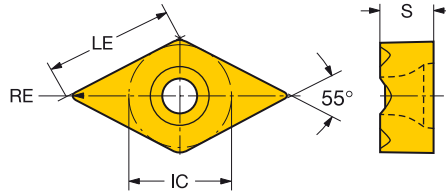
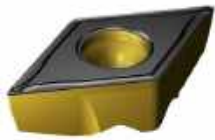

		LE	S	RE	CODICE ISO	P		
						4415	4425	
Finitura	F	13	12.6	5.53	0.40	TR-DC1304-F	★	☆
			.496	.218	.016			
			12.2	5.53	0.79	TR-DC1308-F	★	☆
			.480	.218	.031			
Media	M	13	12.2	5.53	0.79	TR-DC1308-M	☆	★
			.480	.218	.031			
			11.8	5.53	1.19	TR-DC1312-M	☆	★
			.465	.218	.047			

Materiali da taglio innovativi

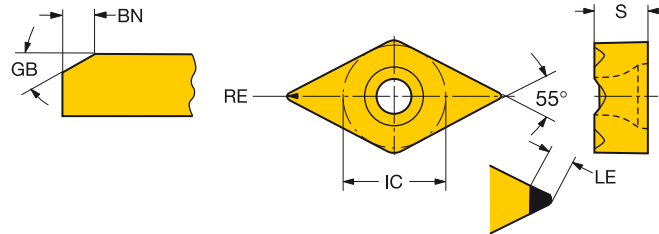
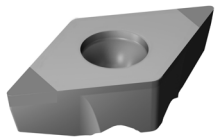

		LE	S	RE	CODICE ISO	S	
						7014	
Finitura	EF	13	3.0	5.53	0.79	TR-DC1308EF	★
			.118	.218	.031		
			2.6	5.53	1.19	TR-DC1312EF	★
			.104	.218	.047		



A26



F2

A

CoroTurn® TR, inserto per tornitura

Inserto di tipo V (romboidale 35°)

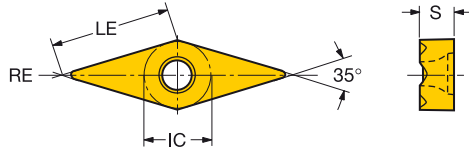

B

Finitura	F	LE	S	RE	CODICE ISO	P		
						4415	4425	
F	F	13	12.6	4.53	0.40	TR-VB1304-F	★	☆
			.496	.178	.016			
			12.2	4.53	0.79	TR-VB1308-F	★	☆
			.480	.178	.031			
			11.8	4.53	1.19	TR-VB1312-F	★	☆
		.465	.178	.047				

C

Materiali da taglio innovativi

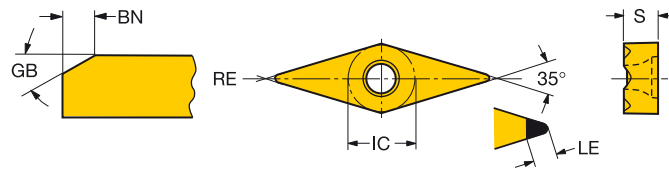
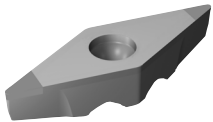

D

Finitura	EF	LE	S	RE	CODICE ISO	S		
						7014		
F	EF	13	3.0	4.53	0.79	TR-VB1308EF	★	
			.118	.178	.031			
			2.1	4.53	1.19	TR-VB1312EF	★	
			.084	.178	.047			

E

F

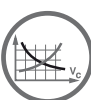

A26



F2

CoroTurn® 107, inserto per tornitura

Inserto di tipo C (romboidale 80°)

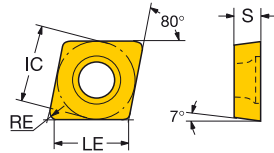
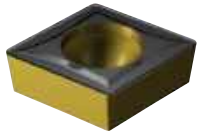

		LE	S	RE	CODICE ISO	P		CODICE ANSI	
						4415	4425		
Finitura	WF	06 1/4	6.0	2.38	0.40	CCMT 06 02 04-WF	★	☆	CCMT 2(1.5)1-WF
			.238	.094	.016				
			5.6	2.38	0.79	CCMT 06 02 08-WF	★	☆	CCMT 2(1.5)2-WF
			.222	.094	.031				
		09 3/8	9.3	3.97	0.40	CCMT 09 T3 04-WF	★	☆	CCMT 3(2.5)1-WF
			.365	.156	.016				
		8.9	3.97	0.79	CCMT 09 T3 08-WF	★	☆	CCMT 3(2.5)2-WF	
		.349	.156	.031					
		06 1/4	6.2	2.38	0.20	CCMT 06 02 02-PF		★	CCMT 2(1.5)0-PF
			.246	.094	.008				
		09 3/8	9.3	3.97	0.40	CCMT 09 T3 04-PF	★	☆	CCMT 3(2.5)1-PF
			.365	.156	.016				
		8.9	3.97	0.79	CCMT 09 T3 08-PF	★	☆	CCMT 3(2.5)2-PF	
		.349	.156	.031					
	12 1/2	12.5	4.76	0.40	CCMT 12 04 04-PF	★	☆	CCMT 431-PF	
		.492	.188	.016					
	06 1/4	6.0	2.38	0.40	CCMT 06 02 04-UF	★	☆	CCMT 2(1.5)1-UF	
		.238	.094	.016					
	09 3/8	9.3	3.97	0.40	CCMT 09 T3 04-UF	★	☆	CCMT 3(2.5)1-UF	
		.365	.156	.016					
Media	WM	06 1/4	5.6	2.38	0.79	CCMT 06 02 08-WM	☆	★	CCMT 2(1.5)2-WM
			.222	.094	.031				
		09 3/8	9.3	3.97	0.40	CCMT 09 T3 04-WM	☆	★	CCMT 3(2.5)1-WM
			.365	.156	.016				
			8.9	3.97	0.79	CCMT 09 T3 08-WM	☆	★	CCMT 3(2.5)2-WM
			.349	.156	.031				
		12 1/2	12.5	4.76	0.40	CCMT 12 04 04-WM	☆	★	CCMT 431-WM
			.492	.188	.016				
			12.1	4.76	0.79	CCMT 12 04 08-WM	☆	★	CCMT 432-WM
			.476	.188	.031				
		06 1/4	6.0	2.38	0.40	CCMT 06 02 04-PM	☆	★	CCMT 2(1.5)1-PM
			.238	.094	.016				
		5.6	2.38	0.79	CCMT 06 02 08-PM	☆	★	CCMT 2(1.5)2-PM	
		.222	.094	.031					
	09 3/8	9.3	3.97	0.40	CCMT 09 T3 04-PM	☆	★	CCMT 3(2.5)1-PM	
		.365	.156	.016					
		8.9	3.97	0.79	CCMT 09 T3 08-PM	☆	★	CCMT 3(2.5)2-PM	
		.349	.156	.031					
	12 1/2	12.5	4.76	0.40	CCMT 12 04 04-PM	☆	★	CCMT 431-PM	
		.492	.188	.016					
		12.1	4.76	0.79	CCMT 12 04 08-PM	☆	★	CCMT 432-PM	
		.476	.188	.031					
		11.7	4.76	1.19	CCMT 12 04 12-PM	☆	★	CCMT 433-PM	
		.460	.188	.047					
	06 1/4	6.0	2.38	0.40	CCMT 06 02 04-UM	☆	★	CCMT 2(1.5)1-UM	
		.238	.094	.016					
	09 3/8	9.3	3.97	0.40	CCMT 09 T3 04-UM	☆	★	CCMT 3(2.5)1-UM	
		.365	.156	.016					
		8.9	3.97	0.79	CCMT 09 T3 08-UM	☆	★	CCMT 3(2.5)2-UM	
		.349	.156	.031					
	12 1/2	12.1	4.76	0.79	CCMT 12 04 08-UM	☆	★	CCMT 432-UM	
		.476	.188	.031					



A26



F2



CoroTurn® 107, inserto per tornitura

Inserto di tipo C (romboidale 80°)

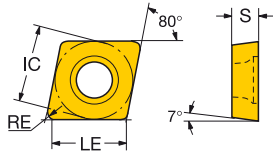
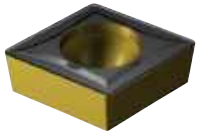

		LE	S	RE	CODICE ISO	P		CODICE ANSI		
						4415	4425			
Sgrossatura	PR	06	1/4	5.6	2.38	0.79	☆	★	CCMT 2(1.5)2-PR	
				.222	.094	.031				
		09	3/8	8.9	3.97	0.79	☆	★	CCMT 3(2.5)2-PR	
				.349	.156	.031				
				8.5	3.97	1.19	☆	★	CCMT 3(2.5)3-PR	
				.334	.156	.047				
		UR	12	1/2	12.1	4.76	0.79	☆	★	CCMT 432-PR
				.476	.188	.031				
				11.7	4.76	1.19	☆	★	CCMT 433-PR	
				.460	.188	.047				
			09	3/8	9.3	3.97	0.40	☆	★	CCMT 3(2.5)1-UR
				.365	.156	.016				
			8.9	3.97	0.79	☆	★	CCMT 3(2.5)2-UR		
			.349	.156	.031					
		12	1/2	12.1	4.76	0.79	☆	★	CCMT 432-UR	
			.476	.188	.031					

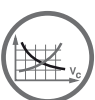

A26



F2

CoroTurn® 107, inserto per tornitura

Inserto di tipo D (romboidale 55°)

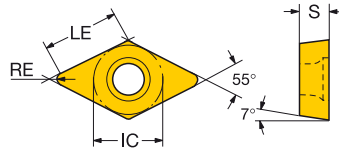
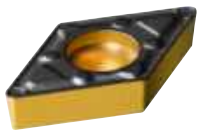

		LE	S	RE	CODICE ISO	P		CODICE ANSI		
						4415	4425			
Finitura	WF	07 1/4	7.4	2.38	0.40	DCMX 07 02 04-WF	★	★	DCMX 2(1.5)1-WF	
			.289	.094	.016					
			7.0	2.38	0.79	DCMX 07 02 08-WF	★	★	DCMX 2(1.5)2-WF	
			.274	.094	.031					
		11 3/8	11.2	3.97	0.40	DCMX 11 T3 04-WF	★	★	DCMX 3(2.5)1-WF	
			.442	.156	.016					
		10.8	3.97	0.79	DCMX 11 T3 08-WF	★	★	DCMX 3(2.5)2-WF		
		.426	.156	.031						
		PF	07 1/4	7.4	2.38	0.40	DCMT 07 02 04-PF	★	★	DCMT 2(1.5)1-PF
			.289	.094	.016					
			7.0	2.38	0.79	DCMT 07 02 08-PF	★	★	DCMT 2(1.5)2-PF	
			.274	.094	.031					
		11 3/8	11.2	3.97	0.40	DCMT 11 T3 04-PF	★	★	DCMT 3(2.5)1-PF	
		.442	.156	.016						
		10.8	3.97	0.79	DCMT 11 T3 08-PF	★	★	DCMT 3(2.5)2-PF		
		.426	.156	.031						
	UF	07 1/4	7.4	2.38	0.40	DCMT 07 02 04-UF	★	★	DCMT 2(1.5)1-UF	
		.289	.094	.016						
		7.0	2.38	0.79	DCMT 07 02 08-UF	★	★	DCMT 2(1.5)2-UF		
		.274	.094	.031						
		11 3/8	11.2	3.97	0.40	DCMT 11 T3 04-UF	★	★	DCMT 3(2.5)1-UF	
		.442	.156	.016						
		10.8	3.97	0.79	DCMT 11 T3 08-UF	★	★	DCMT 3(2.5)2-UF		
		.426	.156	.031						
Media	WM	11 3/8	11.2	3.97	0.40	DCMX 11 T3 04-WM	★	★	DCMX 3(2.5)1-WM	
			.442	.156	.016					
			10.8	3.97	0.79	DCMX 11 T3 08-WM	★	★	DCMX 3(2.5)2-WM	
			.426	.156	.031					
	PM	07 1/4	7.4	2.38	0.40	DCMT 07 02 04-PM	★	★	DCMT 2(1.5)1-PM	
			.289	.094	.016					
			7.0	2.38	0.79	DCMT 07 02 08-PM	★	★	DCMT 2(1.5)2-PM	
			.274	.094	.031					
		11 3/8	11.2	3.97	0.40	DCMT 11 T3 04-PM	★	★	DCMT 3(2.5)1-PM	
			.442	.156	.016					
			10.8	3.97	0.79	DCMT 11 T3 08-PM	★	★	DCMT 3(2.5)2-PM	
			.426	.156	.031					
			10.4	3.97	1.19	DCMT 11 T3 12-PM	★	★	DCMT 3(2.5)3-PM	
			.411	.156	.047					
	UM	07 1/4	7.4	2.38	0.40	DCMT 07 02 04-UM	★	★	DCMT 2(1.5)1-UM	
			.289	.094	.016					
			7.0	2.38	0.79	DCMT 07 02 08-UM	★	★	DCMT 2(1.5)2-UM	
			.274	.094	.031					
11 3/8		11.2	3.97	0.40	DCMT 11 T3 04-UM	★	★	DCMT 3(2.5)1-UM		
		.442	.156	.016						
		10.8	3.97	0.79	DCMT 11 T3 08-UM	★	★	DCMT 3(2.5)2-UM		
		.426	.156	.031						
Sgrossatura	PR	11 3/8	10.8	3.97	0.79	DCMT 11 T3 08-PR	★	★	DCMT 3(2.5)2-PR	
			.426	.156	.031					
			10.4	3.97	1.19	DCMT 11 T3 12-PR	★	★	DCMT 3(2.5)3-PR	
			.411	.156	.047					
	UR	11 3/8	11.2	3.97	0.40	DCMT 11 T3 04-UR	★	★	DCMT 3(2.5)1-UR	
			.442	.156	.016					
			10.8	3.97	0.79	DCMT 11 T3 08-UR	★	★	DCMT 3(2.5)2-UR	
			.426	.156	.031					
			10.4	3.97	1.19	DCMT 11 T3 12-UR	★	★	DCMT 3(2.5)3-UR	
		.411	.156	.047						

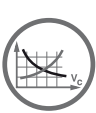

A26



F2



A

CoroTurn® 107, inserto per tornitura

Inserto di tipo S (quadrato)

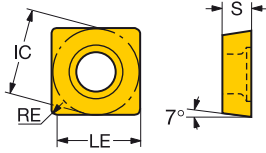
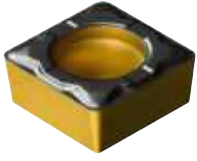

B

C

D

E

F

		LE	S	RE	CODICE ISO	P		CODICE ANSI		
						4415	4425			
Finitura	PF	09 3/8	9.1	3.97	0.40	SCMT 09 T3 04-PF	★	☆	SCMT 3(2.5)1-PF	
			.359	.156	.016					
			8.7	3.97	0.79	SCMT 09 T3 08-PF	★	☆	SCMT 3(2.5)2-PF	
		.344	.156	.031						
	UF	09 3/8	8.7	3.97	0.79	SCMT 09 T3 08-UF	★	☆	SCMT 3(2.5)2-UF	
			.344	.156	.031					
Media	PM	09 3/8	9.1	3.97	0.40	SCMT 09 T3 04-PM	☆	★	SCMT 3(2.5)1-PM	
			.359	.156	.016					
			8.7	3.97	0.79	SCMT 09 T3 08-PM	☆	★	SCMT 3(2.5)2-PM	
			.344	.156	.031					
			12 1/2	12.3	4.76	0.40	SCMT 12 04 04-PM	☆	★	SCMT 431-PM
			.484	.188	.016					
		11.9	4.76	0.79	SCMT 12 04 08-PM	☆	★	SCMT 432-PM		
		.469	.188	.031						
	UM	09 3/8	8.7	3.97	0.79	SCMT 09 T3 08-UM	☆	★	SCMT 3(2.5)2-UM	
			.344	.156	.031					
			12 1/2	11.9	4.76	0.79	SCMT 12 04 08-UM	☆	★	SCMT 432-UM
			.469	.188	.031					
		11.5	4.76	1.19	SCMT 12 04 12-UM	☆	★	SCMT 433-UM		
		.453	.188	.047						
Sgrossatura	PR	09 3/8	8.7	3.97	0.79	SCMT 09 T3 08-PR	☆	★	SCMT 3(2.5)2-PR	
			.344	.156	.031					
			8.3	3.97	1.19	SCMT 09 T3 12-PR	☆	★	SCMT 3(2.5)3-PR	
			.328	.156	.047					
			12 1/2	11.9	4.76	0.79	SCMT 12 04 08-PR	☆	★	SCMT 432-PR
			.469	.188	.031					
		11.5	4.76	1.19	SCMT 12 04 12-PR	☆	★	SCMT 433-PR		
		.453	.188	.047						
	UR	09 3/8	8.7	3.97	0.79	SCMT 09 T3 08-UR	☆	★	SCMT 3(2.5)2-UR	
			.344	.156	.031					
		12 1/2	11.9	4.76	0.79	SCMT 12 04 08-UR	★		SCMT 432-UR	
		.469	.188	.031						

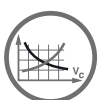

A26



F2

CoroTurn® 107, inserto per tornitura

Inserto di tipo R (rotondo)

Inserti rotondi con interfaccia a binario

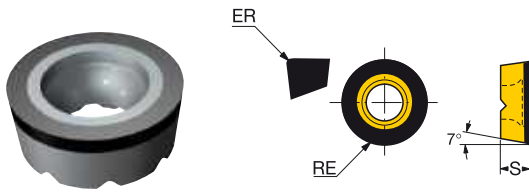

Versione metrica

Media	ED	S	RE	CODICE ISO	S	
					7014	
	08	3.18	4.00	RCGW0803MTED	★	
	10	3.97	5.00	RCGW10T3MTED	★	
	12	4.76	6.00	RCGW1204MUED	★	

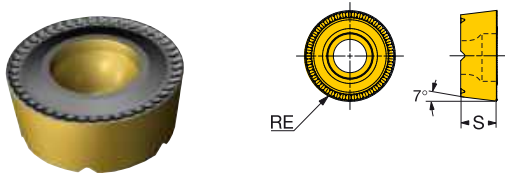

Versione metrica

Finitura	L3	S	RE	CODICE ISO	P	M	S
					4425	1105	2220
	08	3.18	4.00	RCMT 08 03 MP-L3	★	☆	★
	10	3.97	5.00	RCMT 10 T3 MP-L3	★	☆	★
	12	4.76	6.00	RCMT 12 04 MP-L3	★	☆	★
	16	6.35	8.00	RCMT 16 06 MP-L3	★	☆	★
Media	M3						
	08	3.18	4.00	RCMT 08 03 MP-M3	★	☆	★
	10	3.97	5.00	RCMT 10 T3 MP-M3	★	☆	★
	12	4.76	6.00	RCMT 12 04 MP-M3	★	☆	★
	16	6.35	8.00	RCMT 16 06 MP-M3	★	☆	★
Sgrossatura	H7						
	08	3.18	4.00	RCMT 08 03 MP-H7	★	☆	★
	10	3.97	5.00	RCMT 10 T3 MP-H7	★	☆	★
	12	4.76	6.00	RCMT 12 04 MP-H7	★	☆	★
	16	6.35	8.00	RCMT 16 06 MP-H7	★	☆	★

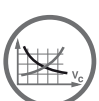

A26



F2

CoroTurn® 107, unità di taglio per tornitura

Sistema di bloccaggio a vite - Per inserti con interfaccia a binario

Coromant Capto® - adduzione interna di refrigerante



RCMT..MP/MT/MU

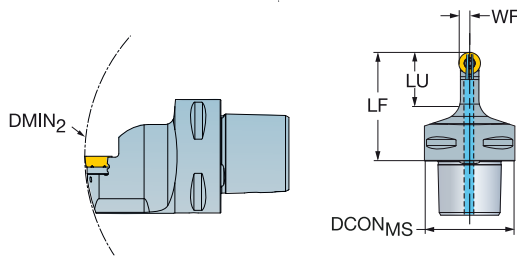

								Dimensioni in mm e pollici								
		CZC _{MS}	DMIN ₂	LU	RMPX	CNSC	Codice di ordinazione	DCON _{MS}	WB	LF	WF				MIID	
08		C5	165.0	28.0	90°	3	C5-SRDCN-00060-08XC	50	6.8	60.0	4.0	150	1.4	0.53	RCMT 08 03 MP	
			6.496	1.102					1.969	.268	2.362	.157	2175			
			C6	190.0	32.0	90°	3	C6-SRDCN-00065-08XC	63	6.8	65.0	4.0	150	1.4	0.89	RCMT 08 03 MP
			7.480	1.260				2.480	.268	2.559	.157	2175				
10		C5	165.0	30.0	90°	3	C5-SRDCN-00060-10XC	50	8.4	60.0	5.0	150	3.0	0.53	RCMT 10 T3 MP	
			6.496	1.181					1.969	.331	2.362	.197	2175			
			C6	190.0	34.0	90°	3	C6-SRDCN-00065-10XC	63	8.4	65.0	5.0	150	3.0	0.89	RCMT 10 T3 MP
			7.480	1.339				2.480	.331	2.559	.197	2175				
12		C5	165.0	30.0	90°	3	C5-SRDCN-00060-12XC	50	10.2	60.0	6.0	150	3.0	0.54	RCMT 12 04 MP	
			6.496	1.181					1.969	.402	2.362	.236	2175			
			C6	190.0	34.0	90°	3	C6-SRDCN-00065-12XC	63	10.2	65.0	6.0	150	3.0	0.91	RCMT 12 04 MP
			7.480	1.339				2.480	.402	2.559	.236	2175				
16		C5	165.0	30.0	90°	3	C5-SRDCN-00060-16XC	50	13.6	60.0	8.0	150	6.4	0.57	RCMT 16 06 MP	
			6.496	1.181					1.969	.535	2.362	.315	2175			
			C6	190.0	34.0	90°	3	C6-SRDCN-00065-16XC	63	13.6	65.0	8.0	150	6.4	0.94	RCMT 16 06 MP
			7.480	1.339				2.480	.535	2.559	.315	2175				

N - Neutra

		Parti di ricambio					
		CZC _{MS}	Vite per inserto	Supporto	Vite del supporto	Ugello	
08	.315	C5-C6	5513 020-04			5691 026-23	
10	.394	C5-C6	5513 020-09			5691 026-13	
12	.472	C5-C6	5513 020-01	5322 160-01 E7F3	5512 090-01	5691 026-13	
16	.630	C5-C6	5513 020-26	5322 160-02 E7F3	5512 090-06	5691 026-03	

Per l'elenco completo delle parti di ricambio, accedere a www.sandvik.coromant.com



CoroTurn[®] 107, unità di taglio per tornitura

Sistema di bloccaggio a vite - Per inserti con interfaccia a binario

Coromant Capto[®] - adduzione interna di refrigerante



RCMT..MP/MT/MU

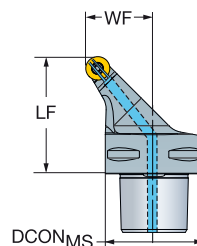
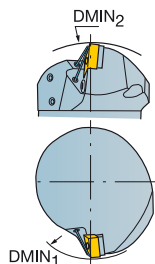
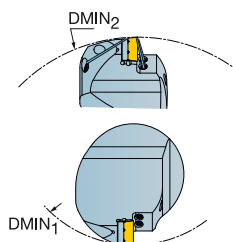

								Dimensioni in mm e pollici						
	CZC _{MS}	DMIN ₁	DMIN ₂	RMPX	CNCS	Codice di ordinazione	DCON _{MS}	LF	WF	BAR	NM	KG	MIID	
										PSI				
08	.315	C5	150.0	165.0	45°	3	C5-SRSCR/L-35060-08XC	50	60.0	35.0	150	1.4	0.61	RCMT 08 03 MP
			5.906	6.496	1.969			2.362	1.378	2175				
	C6	150.0	190.0	45°	3	C6-SRSCR/L-45065-08XC	63	65.0	45.0	150	1.4	1.17	RCMT 08 03 MP	
							5.906	7.480	2.480	2.559	1.772	2175		
10	.394	C5	150.0	165.0	45°	3	C5-SRSCR/L-35060-10XC	50	60.0	35.0	150	3.0	0.62	RCMT 10 T3 MP
			5.906	6.496	1.969			2.362	1.378	2175				
	C6	150.0	190.0	45°	3	C6-SRSCR/L-45065-10XC	63	65.0	45.0	150	3.0	1.17	RCMT 10 T3 MP	
							5.906	7.480	2.480	2.559	1.772	2175		
12	.472	C5	150.0	165.0	45°	3	C5-SRSCR/L-35060-12XC	50	60.0	35.0	150	3.0	0.63	RCMT 12 04 MP
			5.906	6.496	1.969			2.362	1.378	2175				
	C6	150.0	190.0	45°	3	C6-SRSCR/L-45065-12XC	63	65.0	45.0	150	3.0	1.18	RCMT 12 04 MP	
							5.906	7.480	2.480	2.559	1.772	2175		
16	.630	C5	150.0	165.0	45°	3	C5-SRSCR/L-35060-16XC	50	60.0	35.0	150	6.4	0.64	RCMT 16 06 MP
			5.906	6.496	1.969			2.362	1.378	2175				
	C6	150.0	190.0	45°	3	C6-SRSCR/L-45065-16XC	63	65.0	45.0	150	6.4	1.18	RCMT 16 06 MP	
							5.906	7.480	2.480	2.559	1.772	2175		

R = Destro, L = Sinistro

		Parti di ricambio					
	CZC _{MS}	Vite per inserto		Supporto	Vite del supporto		Ugello
		08	.315	C5-C6	5513 020-04		
10	.394	C5-C6	5513 020-09				5691 026-13
12	.472	C5-C6	5513 020-01	5322 160-01	E7F3	5512 090-01	5691 026-03
16	.630	C5-C6	5513 020-26	5322 160-02	E7F3	5512 090-06	5691 026-03

Per l'elenco completo delle parti di ricambio, accedere a www.sandvik.coromant.com



A9



F2



F5

Utensile a stelo CoroTurn® 107 QS per tornitura

Sistema di bloccaggio a vite - Per inserti con interfaccia a binario

Adduzione di refrigerante di precisione



RCMT..MP/MT/MU

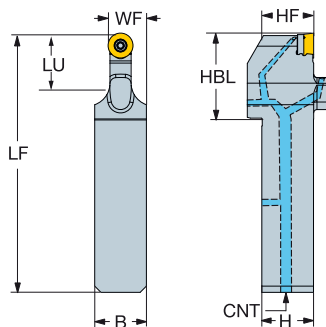

Versione metrica

C		CZC _{MS}	LU	RMPX	OHX	CNSC	Codice di ordinazione	Dimensioni, millimetri								BAR	NM	KG	MIID
								B	H	WB	HBL	LF	WF	HF	CNT				
08		20 x 20	20.0	90°	56.0	3	QS-SRDCN-202020-08XC	20.0	20.0	6.8	36.0	105.0	14.0	20.0	G 1/8-28	150	1.4	0.25	RCMT 08 03 MP
		25 x 25	20.0	90°	61.0	3	QS-SRDCN-252520-08XC	25.0	25.0	6.8	36.0	120.0	16.5	25.0	G 1/8-28	150	1.4	0.46	RCMT 08 03 MP
		25 x 25	40.0	90°	81.0	3	QS-SRDCN-252540-08XC	25.0	25.0	6.8	56.0	140.0	16.5	25.0	G 1/8-28	150	1.4	0.50	RCMT 08 03 MP
10		20 x 20	25.0	90°	60.0	3	QS-SRDCN-202025-10XC	20.0	20.0	8.4	40.0	109.0	15.0	20.0	G 1/8-28	150	3.0	0.27	RCMT 10 T3 MP
		25 x 25	25.0	90°	65.0	3	QS-SRDCN-252525-10XC	25.0	25.0	8.4	40.0	124.0	17.5	25.0	G 1/8-28	150	3.0	0.48	RCMT 10 T3 MP
		25 x 25	40.0	90°	80.0	3	QS-SRDCN-252540-10XC	25.0	25.0	8.4	55.0	139.0	17.5	25.0	G 1/8-28	150	3.0	0.52	RCMT 10 T3 MP
12		20 x 20	25.0	90°	58.0	3	QS-SRDCN-202025-12XC	20.0	20.0	10.2	38.0	107.0	16.0	20.0	G 1/8-28	150	3.0	0.27	RCMT 12 04 MP
		25 x 25	28.0	90°	66.0	3	QS-SRDCN-252528-12XC	25.0	25.0	10.2	41.0	125.0	18.5	25.0	G 1/8-28	150	3.0	0.49	RCMT 12 04 MP
		25 x 25	40.0	90°	78.0	3	QS-SRDCN-252540-12XC	25.0	25.0	10.2	53.0	137.0	20.5	25.0	G 1/8-28	150	3.0	0.52	RCMT 12 04 MP
16		25 x 25	35.0	90°	70.0	3	QS-SRDCN-252535-16XC	25.0	25.0	13.6	45.0	129.0	20.5	25.0	G 1/8-28	150	6.4	0.50	RCMT 16 06 MP

Versione in pollici

D		CZC _{MS}	LU	RMPX	OHX	CNSC	Codice di ordinazione	Dimensioni, pollici								PSI	FT/LBS	LBS	MIID
								B	H	WB	HBL	LF	WF	HF	CNT				
.315		3/4 x 3/4	1.000	90°	2.125	3	QS-SRDCN-12-20-08XC	.750	.750	.268	1.375	4.092	.531	.750	G 1/8-28	2175	1.0	0.494	RCMT 08 03 MP
		1 x 1	.750	90°	2.375	3	QS-SRDCN-16-20-08XC	1.000	1.000	.268	1.375	4.682	.656	1.000	G 1/8-28	2175	1.0	1.045	RCMT 08 03 MP
		1 x 1	1.500	90°	3.125	3	QS-SRDCN-16-40-08XC	1.000	1.000	.268	2.125	5.432	.656	1.000	G 1/8-28	2175	1.0	1.120	RCMT 08 03 MP
.394		3/4 x 3/4	1.000	90°	2.375	3	QS-SRDCN-12-25-10XC	.750	.750	.331	1.625	4.342	.570	.750	G 1/8-28	2175	2.2	0.545	RCMT 10 T3 MP
		1 x 1	1.000	90°	2.625	3	QS-SRDCN-16-25-10XC	1.000	1.000	.331	1.625	4.932	.695	1.000	G 1/8-28	2175	2.2	1.111	RCMT 10 T3 MP
		1 x 1	1.500	90°	3.125	3	QS-SRDCN-16-40-10XC	1.000	1.000	.331	2.125	5.432	.695	1.000	G 1/8-28	2175	2.2	1.175	RCMT 10 T3 MP
.472		3/4 x 3/4	1.000	90°	2.250	3	QS-SRDCN-12-25-12XC	.750	.750	.402	1.500	4.217	.610	.750	G 1/8-28	2175	2.2	0.529	RCMT 12 04 MP
		1 x 1	1.125	90°	2.625	3	QS-SRDCN-16-28-12XC	1.000	1.000	.402	1.625	4.932	.735	1.000	G 1/8-28	2175	2.2	1.102	RCMT 12 04 MP
		1 x 1	1.500	90°	3.125	3	QS-SRDCN-16-40-12XC	1.000	1.000	.402	2.125	5.432	.735	1.000	G 1/8-28	2175	2.2	1.206	RCMT 12 04 MP
.630		1 x 1	1.375	90°	2.750	3	QS-SRDCN-16-35-16XC	1.000	1.000	.535	1.750	5.057	.813	1.000	G 1/8-28	2175	4.7	1.124	RCMT 16 06 MP

R = Destro, L = Sinistro

Parti di ricambio									
		CZC _{MS}	Vite per inserto	Supporto	Vite del supporto	Ugello	Vite	Vite	Vite
08	.315	20 x 20-25 x 25	5513 020-04			5691 026-23	5512 104-01	3214 012-01	3214 013-01
10	.394	20 x 20-25 x 25	5513 020-09			5691 026-13	5512 104-01	3214 012-01	3214 013-01
12	.472	20 x 20-25 x 25	5513 020-01	5322 160-01	E7F3	5512 090-01	5691 026-13	5512 104-01	3214 012-01
16	.630	25 x 25	5513 020-26	5322 160-02	E7F3	5512 090-06	5691 026-03	5512 104-01	3214 012-01

Per l'elenco completo delle parti di ricambio, accedere a www.sandvik.coromant.com



A9



F2



F5

Utensile a stelo CoroTurn® 107 QS per tornitura

Sistema di bloccaggio a vite - Per inserti con interfaccia a binario

Adduzione di refrigerante di precisione



RCMT..MP/MT/MU

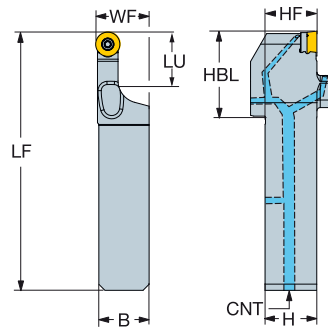

Versione metrica

CZC _{MS}	LU	RMPX	OHX	CNSC	Codice di ordinazione	Dimensioni, millimetri													MIID
						B	H	WB	HBL	LF	WF	HF	CNT	BAR	NM	KG			
08	20 x 20	20.0	90°	59.0	3	QS-SRDCL/L-202020-08XC	20.0	20.0	6.8	39.0	108.0	21.0	20.0	G 1/8-28	150	1.4	0.26	RCMT 08 03 MP	
	25 x 25	20.0	90°	64.0	3	QS-SRDCL/L-252520-08XC	25.0	25.0	6.8	39.0	123.0	26.0	25.0	G 1/8-28	150	1.4	0.47	RCMT 08 03 MP	
10	20 x 20	25.0	90°	63.0	3	QS-SRDCL/L-202025-10XC	20.0	20.0	8.4	43.0	112.0	21.5	20.0	G 1/8-28	150	3.0	0.28	RCMT 10 T3 MP	
	25 x 25	25.0	90°	68.0	3	QS-SRDCL/L-252525-10XC	25.0	25.0	8.4	43.0	127.0	26.5	25.0	G 1/8-28	150	3.0	0.49	RCMT 10 T3 MP	
12	20 x 20	25.0	90°	60.0	3	QS-SRDCL/L-202025-12XC	20.0	20.0	10.2	40.0	109.0	21.5	20.0	G 1/8-28	150	3.0	0.27	RCMT 12 04 MP	
	25 x 25	28.0	90°	69.0	3	QS-SRDCL/L-252528-12XC	25.0	25.0	10.2	44.0	128.0	26.5	25.0	G 1/8-28	150	3.0	0.50	RCMT 12 04 MP	
16	25 x 25	35.0	90°	71.0	3	QS-SRDCL/L-252535-16XC	25.0	25.0	13.6	46.0	130.0	26.5	25.0	G 1/8-28	150	6.4	0.50	RCMT 16 06 MP	

Versione in pollici

CZC _{MS}	LU	RMPX	OHX	CNSC	Codice di ordinazione	Dimensioni, pollici													MIID
						B	H	WB	HBL	LF	WF	HF	CNT	PSI	FT/LBS	LBS			
.315	3/4 x 3/4	.750	90°	2.250	3	QS-SRDCL/L-12-20-08XC	.750	.750	.268	1.500	4.217	.781	.750	G 1/8-28	2175	1.0	0.509	RCMT 08 03 MP	
	1 x 1	.750	90°	2.500	3	QS-SRDCL/L-16-20-08XC	1.000	1.000	.268	1.500	4.807	1.031	1.000	G 1/8-28	2175	1.0	1.067	RCMT 08 03 MP	
.394	3/4 x 3/4	1.000	90°	2.500	3	QS-SRDCL/L-12-25-10XC	.750	.750	.331	1.750	4.467	.813	.750	G 1/8-28	2175	2.2	0.564	RCMT 10 T3 MP	
	1 x 1	1.000	90°	2.750	3	QS-SRDCL/L-16-25-10XC	1.000	1.000	.331	1.750	5.057	1.063	1.000	G 1/8-28	2175	2.2	1.140	RCMT 10 T3 MP	
.472	3/4 x 3/4	1.000	90°	2.375	3	QS-SRDCL/L-12-25-12XC	.750	.750	.402	1.625	4.342	.813	.750	G 1/8-28	2175	2.2	0.551	RCMT 12 04 MP	
	1 x 1	1.125	90°	2.750	3	QS-SRDCL/L-16-28-12XC	1.000	1.000	.402	1.750	5.057	1.063	1.000	G 1/8-28	2175	2.2	1.133	RCMT 12 04 MP	
.630	1 x 1	1.375	90°	2.875	3	QS-SRDCL/L-16-35-16XC	1.000	1.000	.535	1.875	5.182	1.063	1.000	G 1/8-28	2175	4.7	1.155	RCMT 16 06 MP	

R = Destro, L = Sinistro

Parti di ricambio											
CZC _{MS}	Vite per inserto	Supporto	Vite del supporto	Ugello	Vite	Vite	Vite	Vite	Vite		
08	.315	20 x 20-25 x 25	5513 020-04					5691 026-23	5512 104-01	3214 012-01	3214 013-01
10	.394	20 x 20-25 x 25	5513 020-09					5691 026-13	5512 104-01	3214 012-01	3214 013-01
12	.472	20 x 20-25 x 25	5513 020-01	5322 160-01	E7F3	5512 090-01		5691 026-13	5512 104-01	3214 012-01	3214 013-01
16	.630	25 x 25	5513 020-26	5322 160-02	E7F3	5512 090-06		5691 026-03	5512 104-01	3214 012-01	3214 013-01

Per l'elenco completo delle parti di ricambio, accedere a www.sandvik.coromant.com



A9



F2



F5

Testina CoroTurn® 107 per tornitura

Sistema di bloccaggio a vite - Per inserti con interfaccia a binario

CoroTurn® SL70 - Adduzione di refrigerante di precisione



RCMT..MP/MT/MU

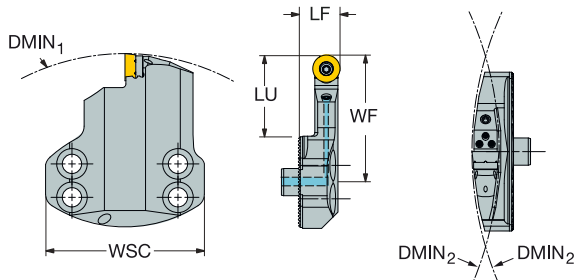

B

C

		Dimensioni in mm e pollici														
CZC _{MS}	DMIN ₁	DMIN ₂	LU	RMPX	CNSC	Codice di ordinazione	WB	LF	WF	WSC	BAR PSI NM KG			MIID		
10	.394	70	120.0	250.0	35.0	90°	1	SL70-SRDCL/L-35-10XC	8.4	17.0	56.0	70.0	70	3.0	0.27	RCMT 10 T3 MP
	4.724	9.843	1.378													
12	.472	70	120.0	300.0	35.0	90°	1	SL70-SRDCL/L-35-12XC	10.2	18.0	56.0	70.0	70	3.0	0.30	RCMT 12 04 MP
	4.724	11.811	1.378													
	70	120.0	260.0	50.0	90°	1	SL70-SRDCL/L-50-12XC	10.2	18.0	71.0	70.0	70	3.0	0.35	RCMT 12 04 MP	
	4.724	10.236	1.969													
	70	120.0	260.0	75.0	90°	1	SL70-SRDCL/L-75-12XC	10.2	18.0	96.0	70.0	70	3.0	0.44	RCMT 12 04 MP	
	4.724	10.236	2.953													

R = Destro, L = Sinistro

D

		Parti di ricambio					
CZC _{MS}	Vite per inserto	Supporto	Vite del supporto	Ugello	Bussola di posizionamento		
10	.394	70	5513 020-09	5322 160-01 E7F3	5512 090-01	5691 026-13	5552 058-04
12	.472	70	5513 020-01			5691 026-13	5552 058-04

Per l'elenco completo delle parti di ricambio, accedere a www.sandvik.coromant.com

E

F



A9



F2



F5

T-Max® P, inserto per tornitura

Inserto di tipo C (romboidale 80°)

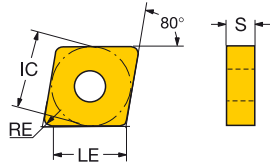
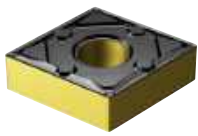

		LE	S	RE	CODICE ISO	P		CODICE ANSI		
						4115	4425			
Finitura	WF	12	1/2	12.5	4.76	0.40	CNMG 12 04 04-WF	★ ☆	CNMG 431-WF	
				.492	.188	.016				
				12.1	4.76	0.79	CNMG 12 04 08-WF	★ ☆	CNMG 432-WF	
				.476	.188	.031				
			11.7	4.76	1.19	CNMG 12 04 12-WF	★ ☆	CNMG 433-WF		
			.460	.188	.047					
	PF	09	3/8	9.3	3.18	0.40	CNMG 09 03 04-PF	★ ☆	CNMG 321-PF	
				.365	.125	.016				
				8.9	3.18	0.79	CNMG 09 03 08-PF	★ ☆	CNMG 322-PF	
				.349	.125	.031				
			12	1/2	12.5	4.76	0.40	CNMG 12 04 04-PF	★ ☆	CNMG 431-PF
			.492	.188	.016					
		12.1	4.76	0.79	CNMG 12 04 08-PF	★ ☆	CNMG 432-PF			
		.476	.188	.031						
		11.7	4.76	1.19	CNMG 12 04 12-PF	★ ☆	CNMG 433-PF			
		.460	.188	.047						
LC	12	1/2	12.5	4.76	0.40	CNMG 12 04 04-LC	★ ☆	CNMG 431-LC		
			.492	.188	.016					
			12.1	4.76	0.79	CNMG 12 04 08-LC	★ ☆	CNMG 432-LC		
		.476	.188	.031						
WL	12	1/2	12.5	4.76	0.40	CNMG 12 04 04-WL	★ ☆	CNMG 431-WL		
			.492	.188	.016					
			12.1	4.76	0.79	CNMG 12 04 08-WL	★ ☆	CNMG 432-WL		
		.476	.188	.031						
XF	12	1/2	12.5	4.76	0.40	CNMG 12 04 04-XF	★ ☆	CNMG 431-XF		
			.492	.188	.016					
			12.1	4.76	0.79	CNMG 12 04 08-XF	★ ☆	CNMG 432-XF		
		.476	.188	.031						
Media	WM	12	1/2	12.1	4.76	0.79	CNMG 12 04 08-WM	☆ ★	CNMG 432-WM	
				.476	.188	.031				
				11.7	4.76	1.19	CNMG 12 04 12-WM	☆ ★	CNMG 433-WM	
				.460	.188	.047				
			16	5/8	14.9	6.35	1.19	CNMG 16 06 12-WM	☆ ★	CNMG 543-WM
			.587	.250	.047					
	WMX	12	1/2	12.1	4.76	0.79	CNMG 12 04 08-WMX	☆ ★	CNMG 432-WMX	
				.476	.188	.031				
			11.7	4.76	1.19	CNMG 12 04 12-WMX	☆ ★	CNMG 433-WMX		
			.460	.188	.047					
		16	5/8	15.3	6.35	0.79	CNMG 16 06 08-WMX	☆ ★	CNMG 542-WMX	
		.603	.250	.031						
		14.9	6.35	1.19	CNMG 16 06 12-WMX	☆ ★	CNMG 543-WMX			
		.587	.250	.047						

B

C

D

E

F



A26



F2

T-Max® P, inserto per tornitura

Inserto di tipo C (romboidale 80°)

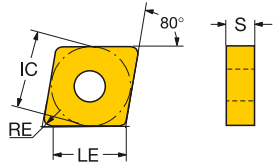
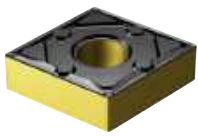

B

C

D

E

F

		LE	S	RE	CODICE ISO	P		CODICE ANSI
						4415	4425	
PM	09 3/8	9.3	3.18	0.40	CNMG 09 03 04-PM	☆	★	CNMG 321-PM
		<i>.365</i>	<i>.125</i>	<i>.016</i>				
		8.9	3.18	0.79	CNMG 09 03 08-PM	☆	★	CNMG 322-PM
		<i>.349</i>	<i>.125</i>	<i>.031</i>				
	12 1/2	12.5	4.76	0.40	CNMG 12 04 04-PM	☆	★	CNMG 431-PM
			<i>.492</i>	<i>.188</i>	<i>.016</i>			
			12.1	4.76	0.79	CNMG 12 04 08-PM	☆	★
			<i>.476</i>	<i>.188</i>	<i>.031</i>			
		11.7	4.76	1.19	CNMG 12 04 12-PM	☆	★	CNMG 433-PM
				<i>.460</i>	<i>.188</i>	<i>.047</i>		
	11.3			4.76	1.59	CNMG 12 04 16-PM	☆	★
		<i>.445</i>	<i>.188</i>	<i>.063</i>				
16 5/8	15.3	6.35	0.79	CNMG 16 06 08-PM	☆	★	CNMG 542-PM	
		<i>.603</i>	<i>.250</i>	<i>.031</i>				
		14.9	6.35	1.19	CNMG 16 06 12-PM	☆	★	CNMG 543-PM
		<i>.587</i>	<i>.250</i>	<i>.047</i>				
	14.5	6.35	1.59	CNMG 16 06 16-PM	☆	★	CNMG 544-PM	
			<i>.572</i>	<i>.250</i>	<i>.063</i>			
19 3/4	18.5	6.35	0.79	CNMG 19 06 08-PM	☆	★	CNMG 642-PM	
		<i>.730</i>	<i>.250</i>	<i>.031</i>				
		18.1	6.35	1.19	CNMG 19 06 12-PM	☆	★	CNMG 643-PM
		<i>.714</i>	<i>.250</i>	<i>.047</i>				
	17.7	6.35	1.59	CNMG 19 06 16-PM	☆	★	CNMG 644-PM	
			<i>.689</i>	<i>.250</i>	<i>.063</i>			
Medium	09 3/8	9.3	3.18	0.40	CNMG 09 03 04-QM	☆	★	CNMG 321-QM
		<i>.365</i>	<i>.125</i>	<i>.016</i>				
		8.9	3.18	0.79	CNMG 09 03 08-QM	☆	★	CNMG 322-QM
		<i>.349</i>	<i>.125</i>	<i>.031</i>				
	12 1/2	12.5	4.76	0.40	CNMG 12 04 04-QM	☆	★	CNMG 431-QM
			<i>.492</i>	<i>.188</i>	<i>.016</i>			
			12.1	4.76	0.79	CNMG 12 04 08-QM	☆	★
			<i>.476</i>	<i>.188</i>	<i>.031</i>			
		11.7	4.76	1.19	CNMG 12 04 12-QM	☆	★	CNMG 433-QM
				<i>.460</i>	<i>.188</i>	<i>.047</i>		
	11.3			4.76	1.59	CNMG 12 04 16-QM	☆	★
		<i>.445</i>	<i>.188</i>	<i>.063</i>				
QM	16 5/8	15.7	6.35	0.40	CNMG 16 06 04-QM	☆	★	CNMG 541-QM
		<i>.619</i>	<i>.250</i>	<i>.016</i>				
		15.3	6.35	0.79	CNMG 16 06 08-QM	☆	★	CNMG 542-QM
		<i>.603</i>	<i>.250</i>	<i>.031</i>				
	14.9	6.35	1.19	CNMG 16 06 12-QM	☆	★	CNMG 543-QM	
			<i>.587</i>	<i>.250</i>	<i>.047</i>			
14.5			6.35	1.59	CNMG 16 06 16-QM	☆	★	CNMG 544-QM
	<i>.572</i>	<i>.250</i>	<i>.063</i>					
19 3/4	18.5	6.35	0.79	CNMG 19 06 08-QM	☆	★	CNMG 642-QM	
		<i>.730</i>	<i>.250</i>	<i>.031</i>				
		18.1	6.35	1.19	CNMG 19 06 12-QM	☆	★	CNMG 643-QM
		<i>.714</i>	<i>.250</i>	<i>.047</i>				
	17.7	6.35	1.59	CNMG 19 06 16-QM	☆	★	CNMG 644-QM	
			<i>.689</i>	<i>.250</i>	<i>.063</i>			
XM	12 1/2	12.5	4.76	0.40	CNMG 12 04 04-XM		★	CNMG 431-XM
		<i>.492</i>	<i>.188</i>	<i>.016</i>				
	12.1	4.76	0.79	CNMG 12 04 08-XM	☆	★	CNMG 432-XM	
		<i>.476</i>	<i>.188</i>	<i>.031</i>				
11.7	4.76	1.19	CNMG 12 04 12-XM	☆	★	CNMG 433-XM		
		<i>.460</i>	<i>.188</i>	<i>.047</i>				

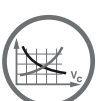

A26



F2

T-Max® P, inserto per tornitura

Inserto di tipo C (romboidale 80°)

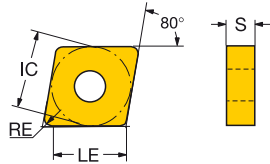
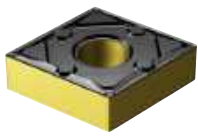

			LE	S	RE	CODICE ISO	P		CODICE ANSI
							4115	4425	
Sgrossatura	PR	12 1/2	12.1	4.76	0.79	CNMG 12 04 08-PR	☆	★	CNMG 432-PR
			.476	.188	.031				
			11.7	4.76	1.19	CNMG 12 04 12-PR	☆	★	CNMG 433-PR
			.460	.188	.047				
		11.3	4.76	1.59	CNMG 12 04 16-PR	☆	★	CNMG 434-PR	
		.445	.188	.063					
		16 5/8	14.9	6.35	1.19	CNMG 16 06 12-PR	☆	★	CNMG 543-PR
			.587	.250	.047				
			14.5	6.35	1.59	CNMG 16 06 16-PR	☆	★	CNMG 544-PR
			.572	.250	.063				
		13.7	6.35	2.38	CNMG 16 06 24-PR	☆	★	CNMG 546-PR	
		.540	.250	.094					
	19 3/4	18.5	6.35	0.79	CNMG 19 06 08-PR	☆	★	CNMG 642-PR	
		.730	.250	.031					
		18.1	6.35	1.19	CNMG 19 06 12-PR	☆	★	CNMG 643-PR	
		.714	.250	.047					
		17.7	6.35	1.59	CNMG 19 06 16-PR	☆	★	CNMG 644-PR	
	.699	.250	.063						
	16.9	6.35	2.38	CNMG 19 06 24-PR	☆	★	CNMG 646-PR		
	.667	.250	.094						
	QR	12 1/2	12.1	4.76	0.79	CNMM 12 04 08-PR	☆	★	CNMM 432-PR
			.476	.188	.031				
			11.7	4.76	1.19	CNMM 12 04 12-PR	☆	★	CNMM 433-PR
			.460	.188	.047				
11.3		4.76	1.59	CNMM 12 04 16-PR	☆	★	CNMM 434-PR		
.445		.188	.063						
16 5/8		15.3	6.35	0.79	CNMM 16 06 08-PR	☆	★	CNMM 542-PR	
		.603	.250	.031					
		14.9	6.35	1.19	CNMM 16 06 12-PR	☆	★	CNMM 543-PR	
		.587	.250	.047					
14.5		6.35	1.59	CNMM 16 06 16-PR	☆	★	CNMM 544-PR		
.572		.250	.063						
19 3/4	18.1	6.35	1.19	CNMM 19 06 12-PR	☆	★	CNMM 643-PR		
	.714	.250	.047						
	17.7	6.35	1.59	CNMM 19 06 16-PR	☆	★	CNMM 644-PR		
	.699	.250	.063						
16.9	6.35	2.38	CNMM 19 06 24-PR	☆	★	CNMM 646-PR			
.667	.250	.094							
QR	12 1/2	12.1	4.76	0.79	CNMM 12 04 08-QR	☆	★	CNMM 432-QR	
		.476	.188	.031					
		11.7	4.76	1.19	CNMM 12 04 12-QR	☆	★	CNMM 433-QR	
		.460	.188	.047					
	11.3	4.76	1.59	CNMM 12 04 16-QR	☆	★	CNMM 434-QR		
	.445	.188	.063						
	16 5/8	14.9	6.35	1.19	CNMM 16 06 12-QR	☆	★	CNMM 543-QR	
		.587	.250	.047					
		14.5	6.35	1.59	CNMM 16 06 16-QR	☆	★	CNMM 544-QR	
		.572	.250	.063					
	13.7	6.35	2.38	CNMM 16 06 24-QR	☆	★	CNMM 546-QR		
	.540	.250	.094						
19 3/4	18.1	6.35	1.19	CNMM 19 06 12-QR	☆	★	CNMM 643-QR		
	.714	.250	.047						
	17.7	6.35	1.59	CNMM 19 06 16-QR	☆	★	CNMM 644-QR		
	.699	.250	.063						
16.9	6.35	2.38	CNMM 19 06 24-QR	☆	★	CNMM 646-QR			
.667	.250	.094							

B

C

D

E

F



A26



F2



T-Max® P, inserto per tornitura

Inserto di tipo C (romboidale 80°)

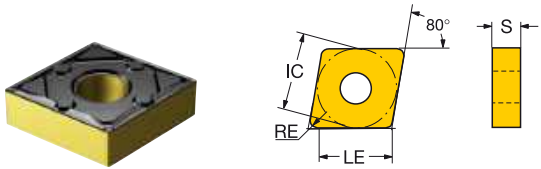

						P			
						4415	4425		
						★	★	CODICE ANSI	
Roughing	XMR	12	1/2	12.1	4.76	0.79	CNMG 12 04 08-XMR	★	CNMG 432-XMR
				.476	.188	.031			
				11.7	4.76	1.19	CNMG 12 04 12-XMR	★	CNMG 433-XMR
				.480	.188	.047			
				11.3	4.76	1.59	CNMG 12 04 16-XMR	★	CNMG 434-XMR
		.445	.188	.063					

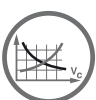

A26



F2

T-Max® P, inserto per tornitura

Inserto di tipo D (romboidale 55°)

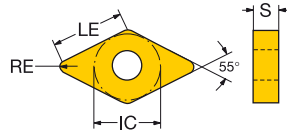
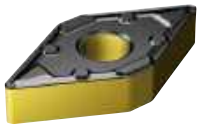

		LE	S	RE	CODICE ISO	P		CODICE ANSI		
						4415	4425			
Finitura	WF	11 3/8	11.2	4.76	0.40	DNMX 11 04 04-WF	★	☆	DNMX 331-WF	
			10.8	4.76	0.79	.426 .188 .031	DNMX 11 04 08-WF	★	☆	DNMX 332-WF
		15 1/2	15.1	4.76	0.40	.595 .188 .016	DNMX 15 04 04-WF	★	☆	DNMX 431-WF
		14.7	4.76	0.79	.579 .188 .031	DNMX 15 04 08-WF	★	☆	DNMX 432-WF	
		15.1	6.35	0.40	.595 .250 .016	DNMX 15 06 04-WF	★	☆	DNMX 441-WF	
		14.7	6.35	0.79	.579 .250 .031	DNMX 15 06 08-WF	★	☆	DNMX 442-WF	
	14.3	6.35	1.19	.563 .250 .047	DNMX 15 06 12-WF	★	☆	DNMX 443-WF		
Finitura	PF	11 3/8	11.2	4.76	0.40	DNMG 11 04 04-PF	★	☆	DNMG 331-PF	
			10.8	4.76	0.79	.426 .188 .031	DNMG 11 04 08-PF	★	☆	DNMG 332-PF
			10.4	4.76	1.19	.411 .188 .047	DNMG 11 04 12-PF	★	☆	DNMG 333-PF
	15 1/2	15.1	4.76	0.40	.595 .188 .016	DNMG 15 04 04-PF	★	☆	DNMG 431-PF	
		14.7	4.76	0.79	.579 .188 .031	DNMG 15 04 08-PF	★	☆	DNMG 432-PF	
		14.3	4.76	1.19	.563 .188 .047	DNMG 15 04 12-PF	★	☆	DNMG 433-PF	
	15.1	6.35	0.40	.595 .250 .016	DNMG 15 06 04-PF	★	☆	DNMG 441-PF		
	14.7	6.35	0.79	.579 .250 .031	DNMG 15 06 08-PF	★	☆	DNMG 442-PF		
	14.3	6.35	1.19	.563 .250 .047	DNMG 15 06 12-PF	★	☆	DNMG 443-PF		
Finitura	LC	11 3/8	10.8	4.76	0.79	DNMG 11 04 08-LC	★	☆	DNMG 332-LC	
			15 1/2	15.1	4.76	0.40	.595 .188 .016	DNMG 15 04 04-LC	★	☆
			14.7	4.76	0.79	.579 .188 .031	DNMG 15 04 08-LC	★	☆	DNMG 432-LC
		14.7	6.35	0.79	.579 .250 .031	DNMG 15 06 08-LC	★	☆	DNMG 442-LC	
Finitura	K	15 1/2	15.1	6.35	0.40	DNMG 15 06 04R/L-K	★	☆	DNMG 441L-K	
				14.7	6.35	0.79	DNMG 15 06 08R/L-K	★	☆	DNMG 442L-K
Finitura	XF	15 1/2	14.7	6.35	0.79	DNMG 15 06 08-XF	★		DNMG 442-XF	

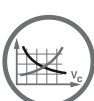

A26



F2

T-Max® P, inserto per tornitura

Inserto di tipo D (romboidale 55°)

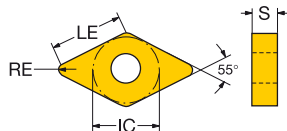
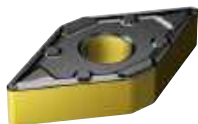

B

C

D

E

F

		LE	S	RE	CODICE ISO	P		CODICE ANSI	
						4415	4425		
WM	11 3/8	10.8	4.76	0.79	DNMX 11 04 08-WM	☆	★	DNMX 332-WM	
		.426	.188	.031	DNMX 11 04 12-WM	☆	★	DNMX 333-WM	
	15 1/2	14.7	4.76	0.79	DNMX 15 04 08-WM	☆	★	DNMX 432-WM	
		.579	.188	.031	DNMX 15 06 08-WM	☆	★	DNMX 442-WM	
		14.3	6.35	1.19	DNMX 15 06 12-WM	☆	★	DNMX 443-WM	
		.563	.250	.047	DNMX 15 06 16-WM	☆	★	DNMX 444-WM	
		13.9	6.35	1.59	DNMX 15 06 16-WM	☆	★	DNMX 444-WM	
		.547	.250	.063					
	WMX	15 1/2	14.7	4.76	0.79	DNMX 15 04 08-WMX	☆	★	DNMX 432-WMX
			.579	.188	.031	DNMX 15 04 12-WMX	☆	★	DNMX 433-WMX
			14.3	4.76	1.19	DNMX 15 06 08-WMX	☆	★	DNMX 442-WMX
			.563	.188	.047	DNMX 15 06 12-WMX	☆	★	DNMX 443-WMX
		14.3	6.35	1.19	DNMX 15 06 12-WMX	☆	★	DNMX 443-WMX	
		.563	.250	.047	DNMX 15 06 16-WMX	☆	★	DNMX 444-WMX	
		13.9	6.35	1.59	DNMX 15 06 16-WMX	☆	★	DNMX 444-WMX	
		.547	.250	.063					
Media		11 3/8	11.2	4.76	0.40	DNMG 11 04 04-PM	☆	★	DNMG 331-PM
			.442	.188	.016	DNMG 11 04 08-PM	☆	★	DNMG 332-PM
			10.8	4.76	0.79	DNMG 11 04 12-PM	☆	★	DNMG 333-PM
			.426	.188	.031				
	15 1/2	15.1	4.76	0.40	DNMG 15 04 04-PM	☆	★	DNMG 431-PM	
		.595	.188	.016	DNMG 15 04 08-PM	☆	★	DNMG 432-PM	
		14.7	4.76	0.79	DNMG 15 04 12-PM	☆	★	DNMG 433-PM	
		.579	.188	.031	DNMG 15 06 04-PM	☆	★	DNMG 441-PM	
		14.3	4.76	1.19	DNMG 15 06 04-PM	☆	★	DNMG 441-PM	
		.563	.188	.047	DNMG 15 06 08-PM	☆	★	DNMG 442-PM	
		15.1	6.35	0.40	DNMG 15 06 08-PM	☆	★	DNMG 442-PM	
		.595	.250	.016	DNMG 15 06 12-PM	☆	★	DNMG 443-PM	
		14.7	6.35	0.79	DNMG 15 06 12-PM	☆	★	DNMG 443-PM	
		.579	.250	.031	DNMG 15 06 16-PM	☆	★	DNMG 444-PM	
		14.3	6.35	1.19	DNMG 15 06 16-PM	☆	★	DNMG 444-PM	
		.563	.250	.047					
		13.9	6.35	1.59	DNMG 15 06 16-PM	☆	★	DNMG 444-PM	
		.547	.250	.063					
		11 3/8	10.4	4.76	1.19	DNMG 11 04 12-QM	☆	★	DNMG 333-QM
			.411	.188	.047	DNMG 15 04 08-QM	☆	★	DNMG 432-QM
	15 1/2		14.7	4.76	0.79	DNMG 15 04 12-QM	☆	★	DNMG 433-QM
			.579	.188	.031	DNMG 15 06 04-QM	☆	★	DNMG 441-QM
		14.3	4.76	1.19	DNMG 15 06 04-QM	☆	★	DNMG 441-QM	
		.563	.188	.047	DNMG 15 06 08-QM	☆	★	DNMG 442-QM	
	15.1	6.35	0.40	DNMG 15 06 08-QM	☆	★	DNMG 442-QM		
	.595	.250	.016	DNMG 15 06 12-QM	☆	★	DNMG 443-QM		
	14.7	6.35	0.79	DNMG 15 06 12-QM	☆	★	DNMG 443-QM		
	.579	.250	.031	DNMG 15 06 16-QM	☆	★	DNMG 444-QM		
	14.3	6.35	1.19	DNMG 15 06 16-QM	☆	★	DNMG 444-QM		
	.563	.250	.047						
	13.9	6.35	1.59	DNMG 15 06 16-QM	☆	★	DNMG 444-QM		
	.547	.250	.063						
XM	15 1/2	14.7	6.35	0.79	DNMG 15 06 08-XM	☆	★	DNMG 442-XM	
		.579	.250	.031	DNMG 15 06 12-XM	☆	★	DNMG 443-XM	
		14.3	6.35	1.19	DNMG 15 06 12-XM	☆	★	DNMG 443-XM	
		.563	.250	.047					

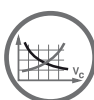

A26



F2

T-Max® P, inserto per tornitura

Inserto di tipo D (romboidale 55°)

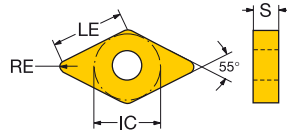
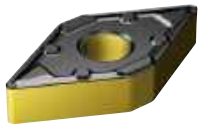

		LE	S	RE	CODICE ISO	P		CODICE ANSI					
						4415	4425						
Sgrossatura	XMR	15	1/2	14.3	6.35	1.19	☆	★	DNMG 15 06 12-XMR	☆	★	DNMG 443-XMR	
				.563	.250	.047							
	PR	15	1/2	14.3	4.76	0.79	☆	★	DNMG 15 04 08-PR	☆	★	DNMG 432-PR	
				.579	.188	.031							
				14.3	4.76	1.19	☆	★	DNMG 15 04 12-PR	☆	★	DNMG 433-PR	
				.563	.188	.047							
				13.9	4.76	1.59	☆	★	DNMG 15 04 16-PR	☆	★	DNMG 434-PR	
				.547	.188	.063							
				14.7	6.35	0.79	☆	★	DNMG 15 06 08-PR	☆	★	DNMG 442-PR	
				.579	.250	.031							
				14.3	6.35	1.19	☆	★	DNMG 15 06 12-PR	☆	★	DNMG 443-PR	
				.563	.250	.047							
				13.9	6.35	1.59	☆	★	DNMG 15 06 16-PR	☆	★	DNMG 444-PR	
				.547	.250	.063							
			19	5/8	18.6	6.35	0.79	☆	★	DNMG 19 06 08-PR	☆	★	DNMG 542-PR
					.731	.250	.031						
		QR	15	1/2	14.7	6.35	0.79	☆	★	DNMM 15 06 08-PR	☆	★	DNMM 442-PR
				.579	.250	.031							
				14.3	6.35	1.19	☆	★	DNMM 15 06 12-PR	☆	★	DNMM 443-PR	
				.563	.250	.047							
				13.9	6.35	1.59	☆	★	DNMM 15 06 16-PR	☆	★	DNMM 444-PR	
				.547	.250	.063							
		15	1/2	14.7	6.35	0.79	☆	★	DNMM 15 06 08-QR	☆	★	DNMM 442-QR	
			.579	.250	.031								
		14.3	6.35	1.19	☆	★	DNMM 15 06 12-QR	☆	★	DNMM 443-QR			
			.563	.250	.047								

B

C

D

E

F



A26



F2

T-Max® P, inserto per tornitura

Inserto di tipo S (quadrato)

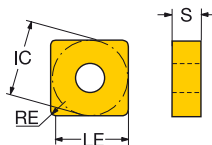
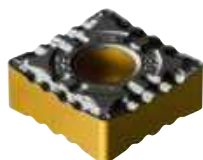

B

C

D

E

F

Finitura	PF	LE	S	RE	CODICE ISO	P		CODICE ANSI						
						4415	4425							
Media	PM	12	1/2	11.9	4.76	0.79	★	☆	SNMG 12 04 08-PF	★	☆	SNMG 432-PF		
				.469	.188	.031								
				11.5	4.76	1.19	★	☆	SNMG 12 04 12-PF	★	☆	SNMG 433-PF		
				.453	.188	.047								
				09	3/8	9.1	3.18	0.40	☆	★	SNMG 09 03 04-PM	☆	★	SNMG 321-PM
				.359	.125	.016								
			09	3/8	8.7	3.18	0.79	☆	★	SNMG 09 03 08-PM	☆	★	SNMG 322-PM	
			.344	.125	.031									
			12	1/2	12.3	4.76	0.40	☆	★	SNMG 12 04 04-PM	☆	★	SNMG 431-PM	
			.484	.188	.016									
			11.9	4.76	0.79	☆	★	SNMG 12 04 08-PM	☆	★	SNMG 432-PM			
			.469	.188	.031									
		11.5	4.76	1.19	☆	★	SNMG 12 04 12-PM	☆	★	SNMG 433-PM				
		.453	.188	.047										
		11.1	4.76	1.59	☆	★	SNMG 12 04 16-PM	☆	★	SNMG 434-PM				
		.437	.188	.063										
		15	5/8	14.7	6.35	1.19	☆	★	SNMG 15 06 12-PM	☆	★	SNMG 543-PM		
		.578	.250	.047										
		14.3	6.35	1.59	★	☆	SNMG 15 06 16-PM	★	☆	SNMG 544-PM				
		.562	.250	.063										
	QM	09	3/8	8.7	3.18	0.79	☆	★	SNMG 09 03 08-QM	☆	★	SNMG 322-QM		
			.344	.125	.031									
			12	1/2	11.9	4.76	0.79	☆	★	SNMG 12 04 08-QM	☆	★	SNMG 432-QM	
			.469	.188	.031									
			11.5	4.76	1.19	☆	★	SNMG 12 04 12-QM	☆	★	SNMG 433-QM			
			.453	.188	.047									
Sgrossatura	PR	12	1/2	11.9	4.76	0.79	☆	★	SNMG 12 04 08-PR	☆	★	SNMG 432-PR		
				.469	.188	.031								
				11.5	4.76	1.19	☆	★	SNMG 12 04 12-PR	☆	★	SNMG 433-PR		
				.453	.188	.047								
				11.1	4.76	1.59	☆	★	SNMG 12 04 16-PR	☆	★	SNMG 434-PR		
				.437	.188	.063								
				15	5/8	15.1	6.35	0.79	☆	★	SNMG 15 06 08-PR	☆	★	SNMG 542-PR
				.594	.250	.031								
				14.7	6.35	1.19	☆	★	SNMG 15 06 12-PR	☆	★	SNMG 543-PR		
				.578	.250	.047								
				14.3	6.35	1.59	☆	★	SNMG 15 06 16-PR	☆	★	SNMG 544-PR		
				.562	.250	.063								
			13.5	6.35	2.38	☆	★	SNMG 15 06 24-PR	☆	★	SNMG 546-PR			
			.531	.250	.094									
			12	1/2	11.9	4.76	0.79	☆	★	SNMM 12 04 08-PR	☆	★	SNMM 432-PR	
			.469	.188	.031									
			11.5	4.76	1.19	☆	★	SNMM 12 04 12-PR	☆	★	SNMM 433-PR			
			.453	.188	.047									
			15	5/8	14.7	6.35	1.19	☆	★	SNMM 15 06 12-PR	☆	★	SNMM 543-PR	
			.578	.250	.047									
			14.3	6.35	1.59	☆	★	SNMM 15 06 16-PR	☆	★	SNMM 544-PR			
			.562	.250	.063									
			19	3/4	17.9	6.35	1.19	☆	★	SNMM 19 06 12-PR	☆	★	SNMM 643-PR	
			.703	.250	.047									
		17.5	6.35	1.59	☆	★	SNMM 19 06 16-PR	☆	★	SNMM 644-PR				
		.687	.250	.063										
		16.7	6.35	2.38	☆	★	SNMM 19 06 24-PR	☆	★	SNMM 646-PR				
		.656	.250	.094										
	QR	19	3/4	17.9	6.35	1.19	☆	★	SNMM 19 06 12-QR	☆	★	SNMM 643-QR		
			.703	.250	.047									
			17.5	6.35	1.59	☆	★	SNMM 19 06 16-QR	☆	★	SNMM 644-QR			
			.687	.250	.063									



A26



F2

T-Max® P, inserto per tornitura

Inserto di tipo T (triangolare)

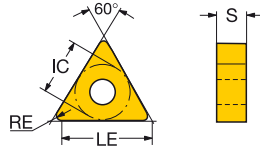
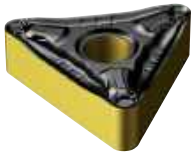

		LE	S	RE	CODICE ISO	P		CODICE ANSI	
						4415	4425		
Media	PM	16	3/8	16.1	4.76	0.40	TNMG 16 04 04-PM	☆ ★	TNMG 331-PM
				.634	.188	.016			
				15.7	4.76	0.79	TNMG 16 04 08-PM	☆ ★	TNMG 332-PM
				.618	.188	.031			
				15.3	4.76	1.19	TNMG 16 04 12-PM	☆ ★	TNMG 333-PM
		.602	.188	.047					
Sgrossatura	PR	16	3/8	15.7	4.76	0.79	TNMG 16 04 08-PR	☆ ★	TNMG 332-PR
				.618	.188	.031			
				15.3	4.76	1.19	TNMG 16 04 12-PR	☆ ★	TNMG 333-PR
				.602	.188	.047			



A26



F2

T-Max® , inserto per tornitura

Inserto di tipo R (rotondo)

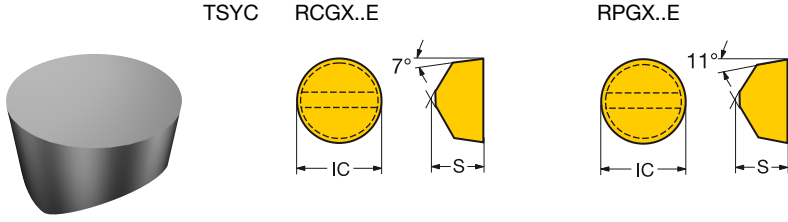

B

Versione metrica

					S
					7014
Media	E			CODICE ISO	★
		S	RE		
		06	6.35 3.18	RCGX060600E	★
			4.76 3.18	RPGX060400E	★
		09	7.94 4.76	RCGX090700E	★
			7.94 4.76	RPGX090700E	★

C

D

E

F



Utensile in metallo duro integrale CoroTurn® XS per tornitura

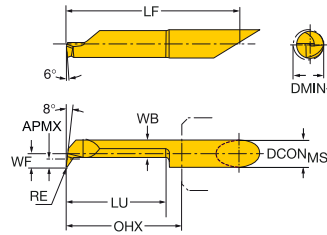

CZC _{MS}	DMIN ₁	LU	OHX	RE	APMX	Codice di ordinazione	Dimensioni, millimetri			DCON _{MS}	WB	LF	WF	RMPX	
							P	M	N						
4	2.7	10.0	13.0	0.05	0.2	CXS-04T098-05-2710R	☆	★	☆	★	4	2.1	27.3	1.2	17°
4	2.7	10.0	13.0	0.15	0.2	CXS-04T098-15-2710R	☆	★	☆	★	4	2.1	27.3	1.2	17°
4	2.7	15.0	18.0	0.15	0.2	CXS-04T098-15-2715R	☆	★	☆	★	4	2.1	32.3	1.2	17°
4	3.2	15.0	18.0	0.05	0.2	CXS-04T098-05-3215R	☆	★	☆	★	4	2.6	32.3	1.5	17°
4	3.2	10.0	13.0	0.15	0.2	CXS-04T098-15-3210R	☆	★	☆	★	4	2.6	27.3	1.5	17°
4	3.2	15.0	18.0	0.15	0.2	CXS-04T098-15-3215R	☆	★	☆	★	4	2.6	32.3	1.5	17°
4	3.2	20.0	23.0	0.15	0.2	CXS-04T098-15-3220R	☆	★	☆	★	4	2.6	37.3	1.5	17°
4	4.2	15.0	18.0	0.05	0.3	CXS-04T098-05-4215R	☆	★	☆	★	4	3.5	32.3	2.0	17°
4	4.2	10.0	13.0	0.15	0.3	CXS-04T098-15-4210R	☆	★	☆	★	4	3.5	27.3	2.0	17°
4	4.2	15.0	18.0	0.15	0.3	CXS-04T098-15-4215R	☆	★	☆	★	4	3.5	32.3	2.0	17°
4	4.2	20.0	23.0	0.15	0.3	CXS-04T098-15-4220R	☆	★	☆	★	4	3.5	37.3	2.0	17°
4	4.2	25.0	28.0	0.15	0.3	CXS-04T098-15-4225R	☆	★	☆	★	4	3.5	42.3	2.0	17°
5	5.2	20.0	23.0	0.05	0.5	CXS-05T098-05-5220R	☆	★	☆	★	5	4.3	42.3	2.5	17°
5	5.2	10.0	13.0	0.20	0.5	CXS-05T098-20-5210R	☆	★	☆	★	5	4.3	32.3	2.5	17°
5	5.2	20.0	23.0	0.20	0.5	CXS-05T098-20-5220R	☆	★	☆	★	5	4.3	42.3	2.5	17°
5	5.2	25.0	28.0	0.20	0.5	CXS-05T098-20-5225R	☆	★	☆	★	5	4.3	47.3	2.5	17°
5	5.2	30.0	33.0	0.20	0.5	CXS-05T098-20-5230R	☆	★	☆	★	5	4.3	52.3	2.5	17°
6	6.2	15.0	18.0	0.20	0.5	CXS-06T098-20-6215R	☆	★	☆	★	6	5.3	37.3	3.0	17°
6	6.2	20.0	23.0	0.20	0.5	CXS-06T098-20-6220R	☆	★	☆	★	6	5.3	42.3	3.0	17°
6	6.2	25.0	28.0	0.20	0.5	CXS-06T098-20-6225R	☆	★	☆	★	6	5.3	47.3	3.0	17°
6	6.2	30.0	33.0	0.20	0.5	CXS-06T098-20-6230R	☆	★	☆	★	6	5.3	52.3	3.0	17°
6	6.2	40.0	43.0	0.20	0.5	CXS-06T098-20-6240R	☆	★	☆	★	6	5.3	62.3	3.0	17°
7	7.2	25.0	28.0	0.20	0.5	CXS-07T098-20-7225R	☆	★	☆	★	7	6.3	47.3	3.5	17°
7	7.2	30.0	33.0	0.20	0.5	CXS-07T098-20-7230R	☆	★	☆	★	7	6.3	52.3	3.5	17°
7	7.2	50.0	53.0	0.20	0.5	CXS-07T098-20-7250R	☆	★	☆	★	7	6.3	72.3	3.5	17°

CZC_{MS} deve corrispondere a CZC_{WS} sull'adattatore.

R = Destro, L = Sinistro



F2

Velocità di taglio consigliate

Le raccomandazioni si riferiscono ad un impiego con fluido da taglio.

ISO P	No. CMC	Acciaio	Forza di taglio specifica k_{c1}	Durezza Brinell	<<<< RESISTENZA ALL'USURA		
					GC4415		GC4425
					h_{ex} mm = avanzamento f_n , mm/giro		
					0.1-0.4-0.8		0.1-0.4-0.8
Codice MC		Materiale	N/mm ²	HB	Velocità di taglio (V_c), m/min		
P1.1.Z.AN	01.1	Acciaio non legato C = 0.1-0.25%	1500	125	560-400-290	500-340-240	
P1.2.Z.AN	01.2	C = 0.25-0.55%	1600	190	565-345-230	550-300-185	
P1.3.Z.AN	01.3	C = 0.55-0.80%	1700	190	455-325-240	395-265-190	
P2.1.Z.AN	02.1	Acciaio debolmente legato (elementi leganti ≤5%) Non trattato	1700	175	440-315-240	430-305-230	
P2.5.Z.HT	02.2	Temprato	1850	330	310-200-145	275-180-135	
P3.0.Z.AN	03.11	Acciaio fortemente legato (elementi leganti >5%) Ricotto	1950	200	410-270-200	300-205-150	
P3.0.Z.HT	03.21	Acciaio per utensili bonificato	3000	380	170-110-80	115-80-65	
P1.5.C.UT	06.1	Getti di acciaio Non legato	1550	150	410-295-230	365-270-195	
P2.6.C.UT	06.2	Debolmente legato (elementi leganti ≤5%)	1600	200	265-185-145	250-170-120	
P3.0.C.UT	06.3	Acciaio fortemente legato (elementi leganti >5%)	2050	200	235-160-120	215-145-105	
ISO M	No. CMC	Acciaio inossidabile	Forza di taglio specifica k_{c1}	Durezza Brinell	<<<< RESISTENZA ALL'USURA		
					GC1105		GC2220
					h_{ex} mm = avanzamento f_n , mm/giro		
					0.1-0.3-0.5		0.2-0.4-0.6
Codice MC		Materiale	N/mm ²	HB	Velocità di taglio (V_c), m/min		
M1.0.Z.AQ	05.21	Austenitico In barre/forgiato	1800	200	215-140-105	225-165-125	
M1.0.Z.PH	05.22	Austenitico Invecchiato artificialmente	2850	300	245-160-110	100-70-55	
M2.0.Z.AQ	05.23	Superaustenitico	2250	200	250-165-115	130-100-75	
M3.1.Z.AQ	05.51	Austenitico-ferritico (Duplex) In barre/forgiato	2000	230	315-205-145	190-150-110	
M3.2.Z.AQ	05.52	Non saldabile ≥ C 0.05% Saldabile C < 0.05%	2450	260	280-185-130	150-120-90	
M1.0.C.UT	15.21	Austenitico Fuso	1700	200	-	200-155-115	
M2.0.C.AQ	15.23	Superaustenitico	2150	200	-	130-90-65	
M3.1.C.AQ	15.51	Austenitico-ferritico (Duplex) Fuso	1800	230	-	150-120-90	
M3.2.C.AQ	15.52	Non saldabile ≥ C 0.05% Saldabile C < 0.05%	2250	260	-	125-105-80	
ISO S	No. CMC	Materiale resistente al calore	Forza di taglio specifica k_{c1}	Durezza Brinell	<<<< RESISTENZA ALL'USURA		
					GC1105		CB7014
					h_{ex} mm = avanzamento f_n , mm/giro		
					0.1-0.3-0.5		0.05-0.15-0.25
Codice MC		Materiale	N/mm ²	HB	Velocità di taglio (V_c), m/min		
S1.0.U.AN	20.11	Superleghe resistenti al calore Base ferro	2400	200	150-100-70	-	
S1.0.U.AG	20.12	Ricotte o solubilizzate Invecchiate o solubilizzate ed invecchiate	2500	280	120-80-60	-	
S2.0.Z.AN	20.21	Base nickel Ricotte o solubilizzate	2650	250	90-55-30	320-280-250	
S2.0.Z.AG	20.22	Invecchiate o solubilizzate ed invecchiate	2900	350	80-50-27	280-245-220	
S2.0.C.NS	20.24	Fuse o fuse ed invecchiate	3000	320	70-45-24	200-155-130	
S3.0.Z.AN	20.31	Base cobalto Ricotte o solubilizzate	2700	200	90-60-30	250-190-160	
S3.0.Z.AG	20.32	Trattate ed invecchiate	3000	300	80-50-27	250-190-160	
S3.0.C.NS	20.33	Fuse o fuse ed invecchiate	3100	320	70-45-24	200-155-130	

Fresatura

Utensili di fresatura ad avanzamenti elevati

CoroMill® 415

B2

Utensili per fresatura a disco

CoroMill® 331, fresa a disco a due tagli regolabile

B3-B6

CoroMill® 331, fresa a disco a due tagli regolabile

B7-B11

Utensili integrali ottimizzati per fresatura

Fresa a candela in metallo duro integrale CoroMill® Plura per fresatura a tuffo

B12-B13

Fresa a candela in metallo duro integrale CoroMill® Plura, per la fresatura laterale ad avanzamenti elevati

B14-B15

Fresa a candela in metallo duro integrale CoroMill® Plura per fresatura multioperazione stabile

B16-B18

Dati di taglio

B19-B21

Per informazioni sulla gamma completa, visitare il sito www.sandvik.coromant.com/it

A

Inserto CoroMill® 415 per fresatura

ITA

B

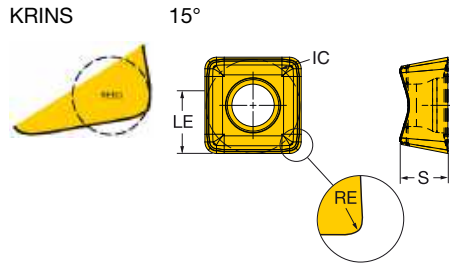
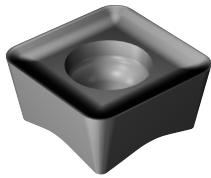

C

	RE	Codice di ordinazione	P					M					S					Dimensioni, millimetri					
			T040	T040	S00T	S00T	S00T	T040	T040	S00T	S00T	S00T	T040	T040	S00T	S00T	S00T	IC	LE	S	BS	BSR	REEQ
M30	05	1.20	415N-05 02 12E-M30	☆	★	☆	☆	☆	☆	☆	☆	☆	☆	☆	☆	☆	☆	5.0	3.0	2.21	0.0	1.2	2.00
	07	2.00	415N-07 03 20E-M30	☆	★	☆	☆	☆	☆	☆	☆	☆	☆	☆	☆	☆	☆	7.0	3.0	3.07	0.0	1.2	2.80

D

E

F



F2

CoroMill® 331, fresa a disco a due tagli regolabile

Foro con sede per chiavetta - adduzione interna di refrigerante





KAPR 90°

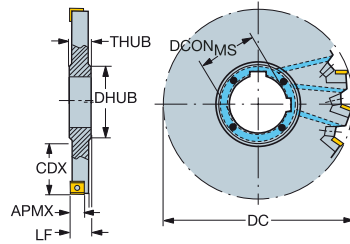

N331.1A



Versione metrica

							Dimensioni, millimetri											
DC	CDX		CZC _{MS}	APMX	CNSC		Codice di ordinazione	DCON _{MS}	LF	DRVCT	DHUB	THUB				RPMX	CICT	MIID
80	19.5	08	27	7.6	1	6	R331.52C-080S27EM	27.0	13.00	1	39.0	16.0	80	1.4	0.23	18100	6	N331.1A-08
100	25.5	08	32	7.6	1	8	R331.52C-100S32EM	32.0	13.00	1	47.0	16.0	80	1.4	0.37	15900	8	N331.1A-08
125	34.0	08	40	7.6	1	10	R331.52C-125S40EM	40.0	13.00	2	55.0	16.0	80	1.4	0.60	14100	10	N331.1A-08
160	51.5	08	40	7.6	1	12	R331.52C-160S40EM	40.0	13.00	1	55.0	16.0	80	1.4	1.10	12400	12	N331.1A-08
80	19.5	08	27	7.6	1	6	R331.52C-080S27FM	27.0	14.00	1	39.0	16.0	80	1.4	0.27	18100	6	N331.1A-08
100	25.5	08	32	7.6	1	8	R331.52C-100S32FM	32.0	14.00	1	47.0	16.0	80	1.4	0.44	15900	8	N331.1A-08
125	34.0	08	40	7.6	1	10	R331.52C-125S40FM	40.0	14.00	2	55.0	16.0	80	1.4	0.72	14100	10	N331.1A-08
160	51.5	08	40	7.6	1	12	R331.52C-160S40FM	40.0	14.00	1	55.0	16.0	80	1.4	1.33	12400	12	N331.1A-08
100	25.5	11	32	10.6	1	6	R331.52C-100S32KM	32.0	16.75	2	47.0	18.5	80	3.0	0.54	14000	6	N331.1A-11
125	34.0	11	40	10.6	1	8	R331.52C-125S40KM	40.0	16.75	1	55.0	18.5	80	3.0	0.88	12400	8	N331.1A-11
160	51.5	11	40	10.6	1	10	R331.52C-160S40KM	40.0	16.75	2	55.0	18.5	80	3.0	1.62	10800	10	N331.1A-11

Codice di ordinazione	Parti di ricambio		
	Vite per inserto	Cuneo	Vite
R331.52C-125S40EM	5513 020-24	5431 105-01	339-831
R331.52C-125S40FM	5513 020-24	5431 105-02	339-831
R331.52C-080S27EM	5513 020-24	5431 105-01	339-831
R331.52C-080S27FM	5513 020-24	5431 105-02	339-831
R331.52C-100S32EM	5513 020-24	5431 105-01	339-831
R331.52C-100S32FM	5513 020-24	5431 105-02	339-831
R331.52C-160S40EM	5513 020-24	5431 105-01	339-831
R331.52C-160S40FM	5513 020-24	5431 105-02	339-831
R331.52C-100S32KM	5513 020-29	5431 105-04	5516 010-02
R331.52C-160S40KM	5513 020-29	5431 105-04	339-831
R331.52C-125S40KM	5513 020-29	5431 105-04	339-831

Per l'elenco completo delle parti di ricambio, accedere a www.sandvik.coromant.com



F2



F5

CoroMill® 331, fresa a disco a due tagli regolabile

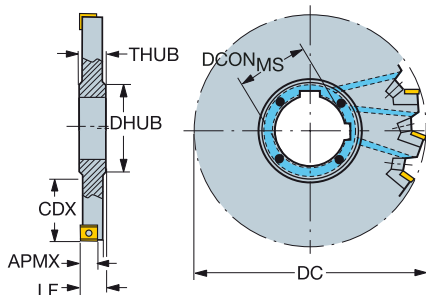

Foro con sede per chiavetta - adduzione interna di refrigerante

KAPR 90°



N331.1A

Versione in pollici

								Dimensioni, pollici											
DC	CDX		CZC _{MS}	APMX	CNSC		Codice di ordinazione	DCON _{MS}	LF	DRVCT	DHUB	THUB	PSI	FT/LBS	LBS	RPMX	CICT	MIID	
3.150	.768	08	1	.299	1	6	R331.52C-080T25FM	1.000	.551	1	1.535	.630	1160	1.0	0.56	18100	6	N331.1A-08	
4.000	1.043	08	1 1/4	.299	1	8	R331.52C-101T32FM	1.250	.551	1	1.811	.630	1160	1.0	0.94	15900	8	N331.1A-08	
5.000	1.437	08	1 1/2	.299	1	10	R331.52C-127T38FM	1.500	.551	2	2.047	.630	1160	1.0	1.59	14100	10	N331.1A-08	
6.000	1.929	08	1 1/2	.299	1	12	R331.52C-152T38FM	1.500	.551	1	2.047	.728	1160	1.0	2.51	12400	12	N331.1A-08	
5.000	1.437	11	1 1/2	.417	1	8	R331.52C-127T38KM	1.500	.659	1	2.047	.728	1160	2.2	2.03	12400	8	N331.1A-11	
6.000	1.929	11	1 1/2	.417	1	10	R331.52C-152T38KM	1.500	.659	2	2.047	.728	1160	2.2	3.15	10800	10	N331.1A-11	

Parti di ricambio			
Codice di ordinazione	Vite per inserto	Cuneo	Vite
R331.52C-080T25FM	5513 020-24	5431 105-02	339-831
R331.52C-101T32FM	5513 020-24	5431 105-02	339-831
R331.52C-127T38FM	5513 020-24	5431 105-02	339-831
R331.52C-152T38FM	5513 020-24	5431 105-02	339-831
R331.52C-152T38KM	5513 020-29	5431 105-04	339-831
R331.52C-127T38KM	5513 020-29	5431 105-04	339-831

Per l'elenco completo delle parti di ricambio, accedere a www.sandvik.coromant.com



CoroMill® 331, fresa a disco a due tagli regolabile



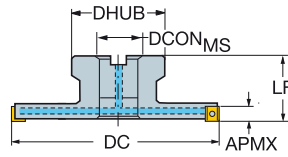

Manicotto - adduzione interna di refrigerante

STDNO ISO6462
KAPR 90°



N331.1A

Versione metrica

						Dimensioni, millimetri											
DC		CZC _{MS}	APMX	CNSC		Codice di ordinazione	DCON _{MS}	ISO	LF	DHUB				RPMX	CICT	MIID	
80	08	27	7.6	1	6	R331.52C-080Q27EMR	27.0	A	50.00	51.0	80	1.4	0.56	18100	6	N331.1A-08	
100	08	27	7.6	1	8	R331.52C-100Q27EMR	27.0	A	50.00	51.0	80	1.4	0.87	15900	8	N331.1A-08	
125	08	32	7.6	1	10	R331.52C-125Q32EMR	32.0	B	50.00	61.0	80	1.4	1.10	14100	10	N331.1A-08	
160	08	40	7.6	1	12	R331.52C-160Q40EMR	40.0	B	50.00	73.0	80	1.4	1.73	12400	12	N331.1A-08	
80	08	27	7.6	1	6	R331.52C-080Q27FMR	27.0	A	50.00	51.0	80	1.4	0.59	18100	6	N331.1A-08	
100	08	27	7.6	1	8	R331.52C-100Q27FMR	27.0	A	50.00	51.0	80	1.4	0.93	15900	8	N331.1A-08	
125	08	32	7.6	1	10	R331.52C-125Q32FMR	32.0	B	50.00	61.0	80	1.4	1.21	14100	10	N331.1A-08	
160	08	40	7.6	1	12	R331.52C-160Q40FMR	40.0	B	50.00	73.0	80	1.4	1.93	12400	12	N331.1A-08	
100	11	27	10.6	1	6	R331.52C-100Q27KMR	27.0	A	50.00	51.0	80	3.0	0.95	14000	6	N331.1A-11	
125	11	32	10.6	1	8	R331.52C-125Q32KMR	32.0	B	50.00	61.0	80	3.0	1.33	12400	8	N331.1A-11	
160	11	40	10.6	1	10	R331.52C-160Q40KMR	40.0	B	50.00	73.0	80	3.0	2.17	10800	10	N331.1A-11	

Parti di ricambio			
Codice di ordinazione	Vite per inserto	Cuneo	Vite
R331.52C-080Q27EMR	5513 020-24	5431 105-01	339-831
R331.52C-080Q27FMR	5513 020-24	5431 105-02	269-832
R331.52C-100Q27EMR	5513 020-24	5431 105-01	339-831
R331.52C-100Q27FMR	5513 020-24	5431 105-02	339-831
R331.52C-125Q32EMR	5513 020-24	5431 105-01	339-831
R331.52C-125Q32FMR	5513 020-24	5431 105-02	339-831
R331.52C-160Q40EMR	5513 020-24	5431 105-01	339-831
R331.52C-160Q40FMR	5513 020-24	5431 105-02	339-831
R331.52C-100Q27KMR	5513 020-29	5431 105-04	339-831
R331.52C-125Q32KMR	5513 020-29	5431 105-04	339-831
R331.52C-160Q40KMR	5513 020-29	5431 105-04	339-831

Per l'elenco completo delle parti di ricambio, accedere a www.sandvik.coromant.com



F2



F5

A

FRESATURA

Utensili per fresatura a disco

CoroMill® 331, fresa a disco a due tagli regolabile

Stelo cilindrico - adduzione interna di refrigerante

KAPR 90°



N331.1A

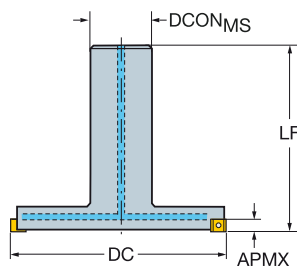

B

Versione metrica

						Dimensioni, millimetri								
DC	CZC _{MS}	APMX	CNSC			DCON _{MS}	LF	BAR	NM	KG	RPMX	CICT	MIID	
80	08	32	7.6	1	6	R331.52C-080A32EMR	32.0	115.00	80	1.4	0.87	15900	6	N331.1A-08
100	08	40	7.6	1	8	R331.52C-100A40EMR	40.0	125.00	80	1.4	1.64	15900	8	N331.1A-08

C

Parti di ricambio			
Codice di ordinazione	Vite per inserto	Cuneo	Vite
R331.52C-080A32EMR	5513 020-24	5431 105-01	339-831
R331.52C-100A40EMR	5513 020-24	5431 105-01	339-831

Per l'elenco completo delle parti di ricambio, accedere a www.sandvik.coromant.com

D

E

F



F2



F5

B 6

SANDVIK
Coromant

CoroMill® 331, fresa a disco a due tagli regolabile

Foro con sede per chiavetta - adduzione interna di refrigerante

KAPR 90°



N331.1A

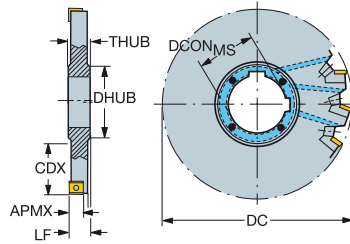

Versione metrica

		Dimensioni, millimetri															
DC	CDX	CZC _{MS}	APMX	CNSC	Codice di ordinazione	DCON _{MS}	LF	DRVCT	DHUB	THUB	BAR	NM	KG	RPMX	CICT	MIID	
80	19.5	08	27	7.6	1 6	L331.52C-080S27EM	27.0	13.00	1	39.0	16.0	80	1.4	0.23	18100	6	N331.1A-08
100	25.5	08	32	7.6	1 8	L331.52C-100S32EM	32.0	13.00	1	47.0	16.0	80	1.4	0.37	15900	8	N331.1A-08
125	34.0	08	40	7.6	1 10	L331.52C-125S40EM	40.0	13.00	2	55.0	16.0	80	1.4	0.60	14100	10	N331.1A-08
160	51.5	08	40	7.6	1 12	L331.52C-160S40EM	40.0	13.00	1	55.0	16.0	80	1.4	1.10	12400	12	N331.1A-08
80	19.5	08	27	7.6	1 6	L331.52C-080S27FM	27.0	14.00	1	39.0	16.0	80	1.4	0.27	18100	6	N331.1A-08
100	25.5	08	32	7.6	1 8	L331.52C-100S32FM	32.0	14.00	1	47.0	16.0	80	1.4	0.44	15900	8	N331.1A-08
125	34.0	08	40	7.6	1 10	L331.52C-125S40FM	40.0	14.00	2	55.0	16.0	80	1.4	0.72	14100	10	N331.1A-08
160	51.5	08	40	7.6	1 12	L331.52C-160S40FM	40.0	14.00	1	55.0	16.0	80	1.4	1.33	12400	12	N331.1A-08
100	25.5	11	32	10.6	1 6	L331.52C-100S32KM	32.0	16.75	2	47.0	18.5	80	3.0	0.54	14000	6	N331.1A-11
125	34.0	11	40	10.6	1 8	L331.52C-125S40KM	40.0	16.75	1	55.0	18.5	80	3.0	0.88	12400	8	N331.1A-11
160	51.5	11	40	10.6	1 10	L331.52C-160S40KM	40.0	16.75	2	55.0	18.5	80	3.0	1.62	10800	10	N331.1A-11

Codice di ordinazione	Parti di ricambio		
	Vite per inserto	Cuneo	Vite
L331.52C-125S40EM	5513 020-24	5431 105-01	339-831
L331.52C-125S40FM	5513 020-24	5431 105-02	339-831
L331.52C-080S27EM	5513 020-24	5431 105-01	339-831
L331.52C-080S27FM	5513 020-24	5431 105-02	339-831
L331.52C-100S32EM	5513 020-24	5431 105-01	339-831
L331.52C-100S32FM	5513 020-24	5431 105-02	339-831
L331.52C-160S40EM	5513 020-24	5431 105-01	339-831
L331.52C-160S40FM	5513 020-24	5431 105-02	339-831
L331.52C-100S32KM	5513 020-29	5431 105-04	5516 010-02
L331.52C-160S40KM	5513 020-29	5431 105-04	339-831
L331.52C-125S40KM	5513 020-29	5431 105-04	339-831

Per l'elenco completo delle parti di ricambio, accedere a www.sandvik.coromant.com



F2



F5

CoroMill® 331, fresa a disco a due tagli regolabile

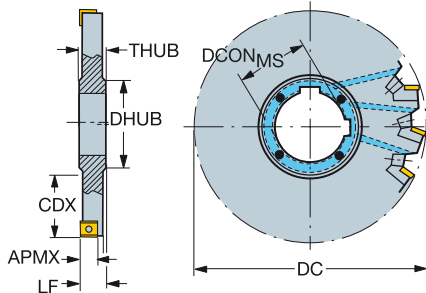

Foro con sede per chiavetta - adduzione interna di refrigerante

KAPR 90°



N331.1A

Versione in pollici

								Dimensioni, pollici											
DC	CDX		CZX _{MS}	APMX	CNSC		Codice di ordinazione	DCON _{MS}	LF	DRVCT	DHUB	THUB	PSI	FT/LBS	LBS	RPMX	CICT	MIID	
3.150	.768	08	1	.299	1	6	L331.52C-080T25FM	1.000	.551	1	1.535	.630	1160	1.0	0.56	18100	6	N331.1A-08	
4.000	1.043	08	1 1/4	.299	1	8	L331.52C-101T32FM	1.250	.551	1	1.811	.630	1160	1.0	0.94	15900	8	N331.1A-08	
5.000	1.437	08	1 1/2	.299	1	10	L331.52C-127T38FM	1.500	.551	2	2.047	.630	1160	1.0	1.59	14100	10	N331.1A-08	
6.000	1.929	08	1 1/2	.299	1	12	L331.52C-152T38FM	1.500	.551	1	2.047	.728	1160	1.0	2.51	12400	12	N331.1A-08	
5.000	1.437	11	1 1/2	.417	1	8	L331.52C-127T38KM	1.500	.659	1	2.047	.728	1160	2.2	2.03	12400	8	N331.1A-11	
6.000	1.929	11	1 1/2	.417	1	10	L331.52C-152T38KM	1.500	.659	2	2.047	.728	1160	2.2	3.15	10800	10	N331.1A-11	

Parti di ricambio			
Codice di ordinazione	Vite per inserto	Cuneo	Vite
L331.52C-080T25FM	5513 020-24	5431 105-02	339-831
L331.52C-101T32FM	5513 020-24	5431 105-02	339-831
L331.52C-127T38FM	5513 020-24	5431 105-02	339-831
L331.52C-152T38FM	5513 020-24	5431 105-02	339-831
L331.52C-152T38KM	5513 020-29	5431 105-04	339-831
L331.52C-127T38KM	5513 020-29	5431 105-04	339-831

Per l'elenco completo delle parti di ricambio, accedere a www.sandvik.coromant.com



F2



F5

CoroMill® 331, fresa a disco a due tagli regolabile



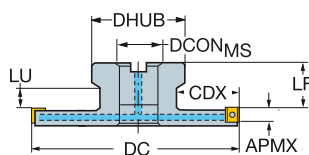

Manicotto - adduzione interna di refrigerante

STDNO ISO6462
KAPR 90°



N331.1A

Versione metrica

							Dimensioni, millimetri											
DC	CDX		CZC _{MS}	APMX	CNSC		Codice di ordinazione	DCON _{MS}	ISO	LF	DHUB				RPMX	CICT	MIID	
80	20.3	08	27	7.6	1	6	R331.52C-080Q27EML	27.0	A	40.00	51.0	80	1.4	0.56	18100	6	N331.1A-08	
100	23.5	08	27	7.6	1	8	R331.52C-100Q27EML	27.0	A	40.00	51.0	80	1.4	0.87	15900	8	N331.1A-08	
125	31.0	08	32	7.6	1	10	R331.52C-125Q32EML	32.0	B	40.00	61.0	80	1.4	1.10	14100	10	N331.1A-08	
160	42.5	08	40	7.6	1	12	R331.52C-160Q40EML	40.0	B	40.00	73.0	80	1.4	1.73	12400	12	N331.1A-08	
80	20.3	08	27	7.6	1	6	R331.52C-080Q27FML	27.0	A	38.00	51.0	80	1.4	0.59	18100	6	N331.1A-08	
100	23.5	08	27	7.6	1	8	R331.52C-100Q27FML	27.0	A	38.00	51.0	80	1.4	0.93	15900	8	N331.1A-08	
125	31.0	08	32	7.6	1	10	R331.52C-125Q32FML	32.0	B	38.00	61.0	80	1.4	1.21	14100	10	N331.1A-08	
160	42.5	08	40	7.6	1	12	R331.52C-160Q40FML	40.0	B	38.00	73.0	80	1.4	1.94	12400	12	N331.1A-08	
100	25.8	11	27	10.6	1	6	R331.52C-100Q27KML	27.0	A	35.00	51.0	80	3.0	0.96	14000	6	N331.1A-11	
125	31.0	11	32	10.6	1	8	R331.52C-125Q32KML	32.0	B	35.00	61.0	80	3.0	1.33	12400	8	N331.1A-11	
160	42.5	11	40	10.6	1	10	R331.52C-160Q40KML	40.0	B	35.00	73.0	80	3.0	2.17	10800	10	N331.1A-11	

Codice di ordinazione	Parti di ricambio		
	Vite per inserto	Cuneo	Vite
R331.52C-080Q27EML	5513 020-24	5431 105-01	339-831
R331.52C-080Q27FML	5513 020-24	5431 105-02	269-832
R331.52C-100Q27EML	5513 020-24	5431 105-01	339-831
R331.52C-100Q27FML	5513 020-24	5431 105-02	339-831
R331.52C-125Q32EML	5513 020-24	5431 105-01	339-831
R331.52C-125Q32FML	5513 020-24	5431 105-02	339-831
R331.52C-160Q40EML	5513 020-24	5431 105-01	339-831
R331.52C-160Q40FML	5513 020-24	5431 105-02	339-831
R331.52C-100Q27KML	5513 020-29	5431 105-04	339-831
R331.52C-125Q32KML	5513 020-29	5431 105-04	339-831
R331.52C-160Q40KML	5513 020-29	5431 105-04	339-831

Per l'elenco completo delle parti di ricambio, accedere a www.sandvik.coromant.com



F2



F5

CoroMill® 331, fresa a disco a due tagli regolabile

Manicotto - adduzione interna di refrigerante

STDNO ISO6462
KAPR 90°

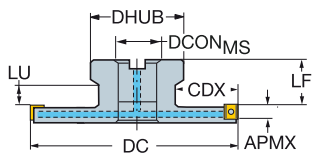

N331.1A

Versione in pollici

							Dimensioni, pollici													
DC	CDX	CDX	CZC _{MS}	APMX	CNSC	6	8	10	6	DCON _{MS}	ISO	LF	DHUB	PSI	FT/LBS	LBS	RPMX	CICT	MIID	
3.150	.799	08	1	.299	1	6				R331.52C-080R25FML	1.000	A	1.528	2.008	1160	1.0	1.31	18100	6	N331.1A-08
4.000	.957	08	1	.299	1	8				R331.52C-101R25FML	1.000	A	1.528	2.008	1160	1.0	2.10	15900	8	N331.1A-08
5.000	1.260	08	1 1/4	.299	1	10				R331.52C-127R32FML	1.250	B	1.528	2.402	1160	1.0	2.65	14100	10	N331.1A-08
4.000	1.016	11	1	.417	1	6				R331.52C-101R25KML	1.000	A	1.409	2.008	1160	2.2	2.26	14000	6	N331.1A-11

Parti di ricambio			
Codice di ordinazione	Vite per inserto	Cuneo	Vite
R331.52C-080R25FML	5513 020-24	5431 105-02	269-832
R331.52C-101R25FML	5513 020-24	5431 105-02	339-831
R331.52C-127R32FML	5513 020-24	5431 105-02	339-831
R331.52C-101R25KML	5513 020-29	5431 105-04	339-831

Per l'elenco completo delle parti di ricambio, accedere a www.sandvik.coromant.com



F2



F5

CoroMill® 331, fresa a disco a due tagli regolabile

Stelo cilindrico - adduzione interna di refrigerante





KAPR 90°

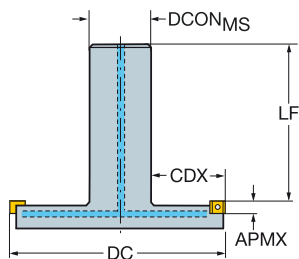

N331.1A



Versione metrica

							Dimensioni, millimetri								
DC	CDX		CZC _{MS}	APMX	CNSC		Codice di ordinazione	DCON _{MS}	LF				RPMX	CICT	MIID
80	23.0	08	32	7.6	1	6	R331.52C-080A32EML	32.0	105.00	80	1.4	0.87	18100	6	N331.1A-08
100	29.0	08	40	7.6	1	8	R331.52C-100A40EML	40.0	115.00	80	1.4	1.49	15900	8	N331.1A-08

Parti di ricambio			
Codice di ordinazione	Vite per inserto	Cuneo	Vite
R331.52C-080A32EML	5513 020-24	5431 105-01	339-831
R331.52C-100A40EML	5513 020-24	5431 105-01	339-831

Per l'elenco completo delle parti di ricambio, accedere a www.sandvik.coromant.com



F2



F5

Fresa a candela in metallo duro integrale CoroMill® Plura per fresatura a tuffo

Per leghe di nichel

FHA 0°
TCDCON h5

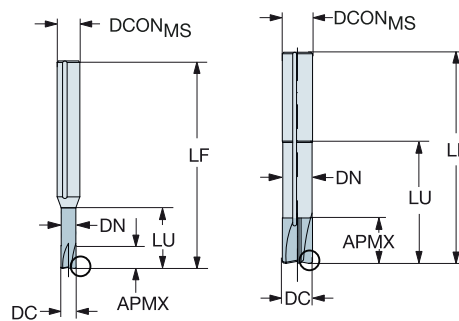
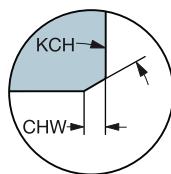

Versione metrica

										s	Dimensioni, millimetri		
DC	CZC _{MS}	APMX	CHW	KCH	LU	CNSC	CXSC	ZEFP	Codice di ordinazione	1610	DCON _{MS}	LF	DN
4.0	6	1.3	0.48	10°	16.0	4	4	4	2P070-0400-PB	★	6.0	54.9	3.9
6.0	6	2.0	0.72	10°	24.0	4	4	4	2P070-0600-PB	★	6.0	60.3	5.8
8.0	8	2.6	0.96	10°	32.0	4	4	4	2P070-0800-PB	★	8.0	68.4	7.8
10.0	10	3.3	1.20	10°	40.0	4	4	4	2P070-1000-PB	★	10.0	80.4	9.7
12.0	12	4.0	1.44	10°	48.0	4	4	4	2P070-1200-PB	★	12.0	92.5	11.6
16.0	16	5.3	1.92	10°	64.0	4	4	4	2P070-1600-PB	★	16.0	111.7	15.5

Versione in pollici

										s	Dimensioni, pollici		
DC	CZC _{MS}	APMX	CHW	KCH	LU	CNSC	CXSC	ZEFP	Codice di ordinazione	1610	DCON _{MS}	LF	DN
.187	1/4	.062	.022	10°	.748	4	4	4	2P070-0476-PB	★	.250	2.264	.182
.250	1/4	.083	.030	10°	1.000	4	4	4	2P070-0635-PB	★	.250	2.429	.243
.375	3/8	.124	.045	10°	1.500	4	4	4	2P070-0953-PB	★	.375	3.091	.364
.500	1/2	.165	.060	10°	2.000	4	4	4	2P070-1270-PB	★	.500	3.756	.485
.625	5/8	.206	.075	10°	2.500	4	4	4	2P070-1588-PB	★	.625	4.378	.606



B19



F2



F5



F6

Fresa a candela in metallo duro integrale CoroMill® Plura per fresatura a tuffo

Per leghe di nichel

FHA 0°
TCDCON h5

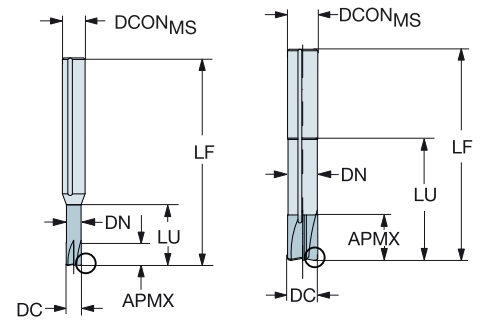
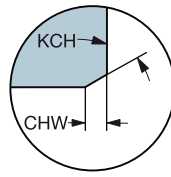

Versione metrica

										s	Dimensioni, millimetri		
DC	CZC _{MS}	APMX	CHW	KCH	LU	CNSC	CXSC	ZEFP	Codice di ordinazione	1610	DCON _{MS}	LF	DN
4.0	6	1.3	0.48	10°	24.0	4	4	4	2P090-0400-PB	★	6.0	62.9	3.9
6.0	6	2.0	0.72	10°	36.0	4	4	4	2P090-0600-PB	★	6.0	72.3	5.8
8.0	8	2.6	0.96	10°	48.0	4	4	4	2P090-0800-PB	★	8.0	84.4	7.8
10.0	10	3.3	1.20	10°	60.0	4	4	4	2P090-1000-PB	★	10.0	100.4	9.7
12.0	12	4.0	1.44	10°	72.0	4	4	4	2P090-1200-PB	★	12.0	116.5	11.6
16.0	16	5.3	1.92	10°	96.0	4	4	4	2P090-1600-PB	★	16.0	143.7	15.5

B

C

D

E

F



B19



F2



F5



F6

Fresa a candela in metallo duro integrale CoroMill® Plura, per la fresatura laterale ad avanzamenti elevati

Per leghe di titanio

FHA 45°
 BSG COROMANT
 TCDC h10
 TCDCON h6

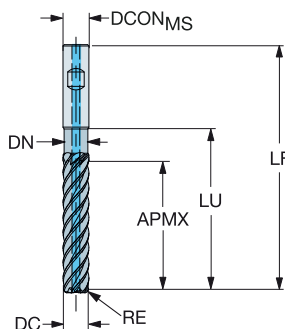

Versione metrica

									s	Dimensioni, millimetri		
DC	CZC _{MS}	APMX	RE	LU	CNSC	CXSC	ZEFP	Codice di ordinazione	1745	DCON _{MS}	LF	DN
6.0	6	30.0	0.50	34.0	1	1	5	2F380-0600-050ASD	★	6.0	72.0	5.7
	6	30.0	1.00	34.0	1	1	5	2F380-0600-100ASD	★	6.0	72.0	5.7
8.0	8	40.0	0.50	45.0	1	1	5	2F380-0800-050ASD	★	8.0	82.0	7.6
	8	40.0	1.00	45.0	1	1	5	2F380-0800-100ASD	★	8.0	82.0	7.6
10.0	10	50.0	0.50	56.0	1	1	5	2F380-1000-050ASD	★	10.0	97.0	9.5
	10	50.0	1.00	56.0	1	1	5	2F380-1000-100ASD	★	10.0	97.0	9.5
	10	50.0	2.00	56.0	1	1	5	2F380-1000-200ASD	★	10.0	97.0	9.5
12.0	12	60.0	1.00	67.0	1	1	5	2F380-1200-100ASD	★	12.0	115.0	11.4
	12	60.0	2.00	67.0	1	1	5	2F380-1200-200ASD	★	12.0	115.0	11.4
	12	60.0	2.50	67.0	1	1	5	2F380-1200-250ASD	★	12.0	115.0	11.4
	12	60.0	3.00	67.0	1	1	5	2F380-1200-300ASD	★	12.0	115.0	11.4
16.0	16	80.0	2.00	89.0	1	1	5	2F380-1600-200ASD	★	16.0	140.0	15.2
	16	80.0	2.50	89.0	1	1	5	2F380-1600-250ASD	★	16.0	140.0	15.2
	16	80.0	3.00	89.0	1	1	5	2F380-1600-300ASD	★	16.0	140.0	15.2
	16	80.0	4.00	89.0	1	1	5	2F380-1600-400ASD	★	16.0	140.0	15.2
20.0	20	100.0	3.00	111.0	1	1	5	2F380-2000-300ASD	★	20.0	165.0	19.0
	20	100.0	4.00	111.0	1	1	5	2F380-2000-400ASD	★	20.0	165.0	19.0
	20	100.0	6.35	111.0	1	1	5	2F380-2000-635ASD	★	20.0	165.0	19.0
25.0	25	125.0	3.00	138.5	1	1	5	2F380-2500-300ASD	★	25.0	203.0	23.8
	25	125.0	4.00	138.5	1	1	5	2F380-2500-400ASD	★	25.0	203.0	23.8
	25	125.0	6.35	138.5	1	1	5	2F380-2500-635ASD	★	25.0	203.0	23.8

E

F



Fresa a candela in metallo duro integrale CoroMill® Plura, per la fresatura laterale ad avanzamenti elevati

Per leghe di titanio

FHA 45°
 BSG COROMANT
 TCDC h10
 TCDCON h6

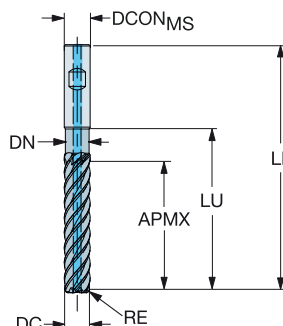

Versione in pollici

								s Dimensioni, pollici				
DC	CZC _{MS}	APMX	RE	LU	CNSC	CXSC	ZEFP	Codice di ordinazione	1745	DCON _{MS}	LF	DN
.250	1/4	1.250	.030	1.406	1	1	5	2F380-0635-076ASD	★	.250	2.938	.237
	1/4	1.250	.060	1.406	1	1	5	2F380-0635-152ASD	★	.250	2.938	.237
.375	3/8	1.875	.030	2.094	1	1	5	2F380-0953-076ASD	★	.375	3.750	.356
	3/8	1.875	.060	2.094	1	1	5	2F380-0953-152ASD	★	.375	3.750	.356
.500	3/8	1.875	.090	2.094	1	1	5	2F380-0953-228ASD	★	.375	3.750	.356
	1/2	2.500	.030	2.781	1	1	5	2F380-1270-076ASD	★	.500	4.688	.475
.500	1/2	2.500	.060	2.781	1	1	5	2F380-1270-152ASD	★	.500	4.688	.475
	1/2	2.500	.090	2.781	1	1	5	2F380-1270-228ASD	★	.500	4.688	.475
.500	1/2	2.500	.120	2.781	1	1	5	2F380-1270-304ASD	★	.500	4.688	.475
	5/8	3.125	.030	3.469	1	1	5	2F380-1588-076ASD	★	.625	5.500	.594
.625	5/8	3.125	.060	3.469	1	1	5	2F380-1588-152ASD	★	.625	5.500	.594
	5/8	3.125	.090	3.469	1	1	5	2F380-1588-228ASD	★	.625	5.500	.594
.625	5/8	3.125	.120	3.469	1	1	5	2F380-1588-304ASD	★	.625	5.500	.594
	3/4	3.781	.030	4.156	1	1	5	2F380-1905-076ASD	★	.750	6.375	.713
.750	3/4	3.781	.060	4.156	1	1	5	2F380-1905-152ASD	★	.750	6.375	.713
	3/4	3.781	.090	4.156	1	1	5	2F380-1905-228ASD	★	.750	6.375	.713
.750	3/4	3.781	.120	4.156	1	1	5	2F380-1905-304ASD	★	.750	6.375	.713
	1	5.031	.030	5.531	1	1	5	2F380-2540-076ASD	★	1.000	8.125	.950
1.000	1	5.031	.060	5.531	1	1	5	2F380-2540-152ASD	★	1.000	8.125	.950
	1	5.031	.090	5.531	1	1	5	2F380-2540-228ASD	★	1.000	8.125	.950
1.000	1	5.031	.120	5.531	1	1	5	2F380-2540-304ASD	★	1.000	8.125	.950

B

C

D

E

F

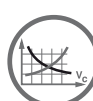

B20



F2



F5



F6

Fresa a candela in metallo duro integrale CoroMill® Plura per fresatura multioperazione stabile

Per superleghe resistenti al calore

FHA
BSG
TCDC
TCDCON

50°
DIN 6527 L
h9
h6

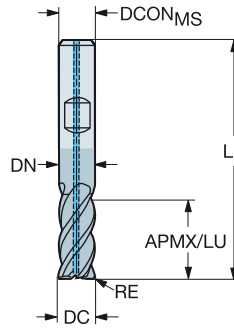

Versione metrica

									s Dimensioni, millimetri			
DC	CZC _{MS}	APMX	RE	LU	CNSC	CXSC	ZEFP	Codice di ordinazione	1725	DCON _{MS}	LF	DN
6.0	6	13.0	0.50	19.0	1	1	4	2F440-0600-050ASD	★	6.0	57.0	5.7
	6	13.0	1.00	19.0	1	1	4	2F440-0600-100ASD	★	6.0	57.0	5.7
8.0	8	19.0	0.50	25.0	1	1	4	2F440-0800-050ASD	★	8.0	63.0	7.6
	8	19.0	1.00	25.0	1	1	4	2F440-0800-100ASD	★	8.0	63.0	7.6
10.0	10	22.0	0.50	30.0	1	1	4	2F440-1000-050ASD	★	10.0	72.0	9.5
	10	22.0	1.00	30.0	1	1	4	2F440-1000-100ASD	★	10.0	72.0	9.5
10.0	10	22.0	2.00	30.0	1	1	4	2F440-1000-200ASD	★	10.0	72.0	9.5
	12.0	12	26.0	0.50	36.0	1	1	4	2F440-1200-050ASD	★	12.0	83.0
12.0	12	26.0	1.00	36.0	1	1	4	2F440-1200-100ASD	★	12.0	83.0	11.4
	12	26.0	2.00	36.0	1	1	4	2F440-1200-200ASD	★	12.0	83.0	11.4
16.0	16	32.0	2.00	42.0	1	1	4	2F440-1600-200ASD	★	16.0	92.0	15.2
	16	32.0	3.00	42.0	1	1	4	2F440-1600-300ASD	★	16.0	92.0	15.2
16.0	16	32.0	4.00	42.0	1	1	4	2F440-1600-400ASD	★	16.0	92.0	15.2
	20.0	20	38.0	3.00	52.0	1	1	4	2F440-2000-300ASD	★	20.0	104.0
20.0	20	38.0	4.00	52.0	1	1	4	2F440-2000-400ASD	★	20.0	104.0	19.0
	20	38.0	6.35	52.0	1	1	4	2F440-2000-635ASD	★	20.0	104.0	19.0

Versione in pollici

									s Dimensioni, pollici			
DC	CZC _{MS}	APMX	RE	LU	CNSC	CXSC	ZEFP	Codice di ordinazione	1725	DCON _{MS}	LF	DN
.250	1/4	.625	.030	.875	1	1	4	2F440-0635-076ASD	★	.250	2.500	.237
	1/4	.625	.060	.875	1	1	4	2F440-0635-152ASD	★	.250	2.500	.237
.375	3/8	.781	.030	1.156	1	1	4	2F440-0953-076ASD	★	.375	3.000	.356
	3/8	.781	.060	1.156	1	1	4	2F440-0953-152ASD	★	.375	3.000	.356
.375	3/8	.781	.090	1.156	1	1	4	2F440-0953-228ASD	★	.375	3.000	.356
	.500	1/2	1.125	.030	1.438	1	1	4	2F440-1270-076ASD	★	.500	3.500
.500	1/2	1.125	.060	1.438	1	1	4	2F440-1270-152ASD	★	.500	3.500	.475
	1/2	1.125	.090	1.438	1	1	4	2F440-1270-228ASD	★	.500	3.500	.475
.500	1/2	1.125	.120	1.438	1	1	4	2F440-1270-304ASD	★	.500	3.500	.475
	.625	5/8	1.313	.030	1.563	1	1	4	2F440-1588-076ASD	★	.625	3.750
.625	5/8	1.313	.060	1.563	1	1	4	2F440-1588-152ASD	★	.625	3.750	.594
	5/8	1.313	.090	1.563	1	1	4	2F440-1588-228ASD	★	.625	3.750	.594
.625	5/8	1.313	.120	1.563	1	1	4	2F440-1588-304ASD	★	.625	3.750	.594
	.750	3/4	1.625	.030	1.937	1	1	4	2F440-1905-076ASD	★	.750	4.250
.750	3/4	1.625	.060	1.937	1	1	4	2F440-1905-152ASD	★	.750	4.250	.713
	3/4	1.625	.090	1.937	1	1	4	2F440-1905-228ASD	★	.750	4.250	.713
.750	3/4	1.625	.120	1.937	1	1	4	2F440-1905-304ASD	★	.750	4.250	.713

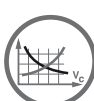

B21



F2



F5



F6

Fresa a candela in metallo duro integrale CoroMill® Plura per fresatura multioperazione stabile

Per superleghe resistenti al calore

FHA
BSG
TCDC
TCDCON

50°
DIN 6527 L
h9
h6

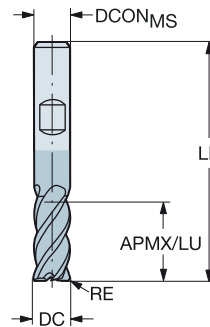

Versione metrica

						s Dimensioni, millimetri				
DC	CZC _{MS}	APMX	RE	LU	ZEFP	Codice di ordinazione	1725	DCON _{MS}	LF	DN
2.0	6	7.0	0.20	9.5	3	2S440-0200-020-SD	★	6.0	57.0	1.9
3.0	6	8.0	0.30	10.0	3	2S440-0300-030-SD	★	6.0	57.0	2.9
4.0	6	11.0	0.50	15.0	3	2S440-0400-050-SD	★	6.0	57.0	3.8
5.0	6	13.0	0.50	16.0	3	2S440-0500-050-SD	★	6.0	57.0	4.8
6.0	6	13.0	0.50	19.0	4	2S440-0600-050-SD	★	6.0	57.0	5.7
	6	13.0	1.00	19.0	4	2S440-0600-100-SD	★	6.0	57.0	5.7
8.0	8	19.0	0.50	25.0	4	2S440-0800-050-SD	★	8.0	63.0	7.6
	8	19.0	1.00	25.0	4	2S440-0800-100-SD	★	8.0	63.0	7.6
10.0	10	22.0	0.50	30.0	4	2S440-1000-050-SD	★	10.0	72.0	9.5
	10	22.0	1.00	30.0	4	2S440-1000-100-SD	★	10.0	72.0	9.5
	10	22.0	2.00	30.0	4	2S440-1000-200-SD	★	10.0	72.0	9.5
12.0	12	26.0	0.50	36.0	4	2S440-1200-050-SD	★	12.0	83.0	11.4
	12	26.0	1.00	36.0	4	2S440-1200-100-SD	★	12.0	83.0	11.4
	12	26.0	2.00	36.0	4	2S440-1200-200-SD	★	12.0	83.0	11.4
16.0	16	32.0	2.00	42.0	4	2S440-1600-200-SD	★	16.0	92.0	15.2
	16	32.0	3.00	42.0	4	2S440-1600-300-SD	★	16.0	92.0	15.2
	16	32.0	4.00	42.0	4	2S440-1600-400-SD	★	16.0	92.0	15.2
20.0	20	38.0	3.00	52.0	4	2S440-2000-300-SD	★	20.0	104.0	19.0
	20	38.0	4.00	52.0	4	2S440-2000-400-SD	★	20.0	104.0	19.0
	20	38.0	6.35	52.0	4	2S440-2000-635-SD	★	20.0	104.0	19.0

Versione in pollici

						s Dimensioni, pollici				
DC	CZC _{MS}	APMX	RE	LU	ZEFP	Codice di ordinazione	1725	DCON _{MS}	LF	DN
.250	1/4	.625	.030	.875	4	2S440-0635-076-SD	★	.250	2.500	.237
	1/4	.625	.060	.875	4	2S440-0635-152-SD	★	.250	2.500	.237
.375	3/8	.781	.030	1.156	4	2S440-0953-076-SD	★	.375	3.000	.356
	3/8	.781	.060	1.156	4	2S440-0953-152-SD	★	.375	3.000	.356
	3/8	.781	.090	1.156	4	2S440-0953-228-SD	★	.375	3.000	.356
.500	1/2	1.125	.030	1.438	4	2S440-1270-076-SD	★	.500	3.500	.475
	1/2	1.125	.060	1.438	4	2S440-1270-152-SD	★	.500	3.500	.475
	1/2	1.125	.090	1.438	4	2S440-1270-228-SD	★	.500	3.500	.475
	1/2	1.125	.120	1.438	4	2S440-1270-304-SD	★	.500	3.500	.475
.625	5/8	1.313	.030	1.563	4	2S440-1588-076-SD	★	.625	3.750	.594
	5/8	1.313	.060	1.563	4	2S440-1588-152-SD	★	.625	3.750	.594
	5/8	1.313	.090	1.563	4	2S440-1588-228-SD	★	.625	3.750	.594
	5/8	1.313	.120	1.563	4	2S440-1588-304-SD	★	.625	3.750	.594
.750	3/4	1.625	.030	1.937	4	2S440-1905-076-SD	★	.750	4.250	.713
	3/4	1.625	.060	1.937	4	2S440-1905-152-SD	★	.750	4.250	.713
	3/4	1.625	.090	1.937	4	2S440-1905-228-SD	★	.750	4.250	.713
	3/4	1.625	.120	1.937	4	2S440-1905-304-SD	★	.750	4.250	.713



B21



F2



F5



F6

A

FRESATURA

Utensili integrali ottimizzati per fresatura

Fresa a candela in metallo duro integrale CoroMill® Plura per fresatura multioperazione stabile

Per superleghe resistenti al calore

FHA 50°
 BSG DIN 6527 L
 TCDC h9
 TCDCON h6

B

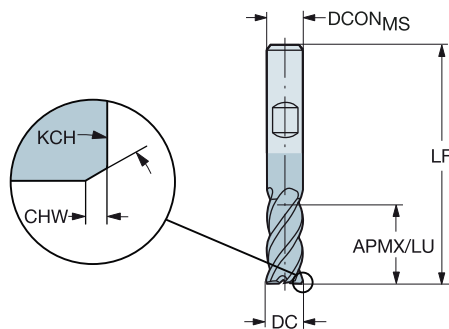

Versione metrica

C

							s Dimensioni, millimetri				
DC	CZC _{MS}	APMX	CHW	KCH	LU	ZEFP	Codice di ordinazione	1725	DCON _{MS}	LF	DN
6.0	6	13.0	0.10	45°	19.0	4	2P440-0600-SD	★	6.0	57.0	5.7
8.0	8	19.0	0.10	45°	25.0	4	2P440-0800-SD	★	8.0	63.0	7.6
10.0	10	22.0	0.10	45°	30.0	4	2P440-1000-SD	★	10.0	72.0	9.5
12.0	12	26.0	0.10	45°	36.0	4	2P440-1200-SD	★	12.0	83.0	11.4
16.0	16	32.0	0.15	45°	42.0	4	2P440-1600-SD	★	16.0	92.0	15.2
20.0	20	38.0	0.15	45°	52.0	4	2P440-2000-SD	★	20.0	104.0	19.0

D

E

F

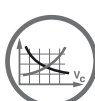

B21



F2



F5



F6

B 18

SANDVIK
Coromant

Velocità di taglio consigliate

Ottimizzata - Fresa a candela in metallo duro integrale CoroMill® Plura per fresatura a tuffo in leghe a base di nichel

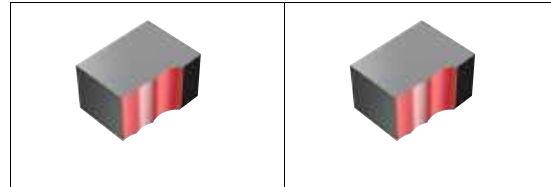

$$a_e = 0.3 \times DC$$

$$a_p = 4 \times DC$$



$$a_e = 0.3 \times DC$$

$$a_p = 6 \times DC$$

ISO	Codice MC	CMC	Materiale	HB						
					fz mm/dente	v_c m/min	v_c piedi/min	fz mm/dente	v_c m/min	v_c piedi/min
S	S2.0.Z.AG	20.22	Leghe a base di nichel	400	0,02-0,05	25	82	B04	25	82

Velocità di taglio consigliate

Ottimizzata - Fresa a candela in metallo duro integrale CoroMill® Plura per fresatura laterale ad avanzamenti elevati in leghe di titanio

												
$a_e = 0.07 \times DC$	$a_e = 0.033 \times DC$	$a_e = 0.2 \text{ mm}$										
$a_p = 5.0 \times DC$	$a_p = 5.0 \times DC$	$a_p = 5.0 \times DC$										
ISO	Codice MC	Materiale	HB	f_z	$v_c \text{ m/min}$	$v_c \text{ piedi/min}$	f_z	$v_c \text{ m/min}$	$v_c \text{ piedi/min}$	f_z	$v_c \text{ m/min}$	$v_c \text{ piedi/min}$
S	S4.3.Z.AN	Leghe in titanio Alfa/Beta	330	T01	80	262	T02	120	394	T03	180	590
	S4.4.Z.AN	Leghe in titanio Beta	410	T01	60	197	T02	90	295	T03	120	394

Avanzamenti consigliati



mm/dente

pollici/dente

D_c	6.000	6.350	8.000	9.525	10.000	12.000	12.700	15.875	16.000	19.050	20.000	25.000	25.400
f_z	0.236	0.250	0.315	0.375	0.394	0.472	0.500	0.625	0.630	0.750	0.787	0.984	1.000
T01	0.020	0.021	0.023	0.023	0.024	0.025	0.025	0.026	0.027	0.027	0.028	0.0292	0.029
	.0008	.0008	.0009	.0009	.0009	.0010	.0010	.0010	.0010	.0011	.0011	.0011	.0012
T02	0.032	0.033	0.036	0.037	0.038	0.040	0.041	0.042	0.042	0.044	0.045	0.0467	0.047
	.0013	.0013	.0014	.0015	.0015	.0016	.0016	.0017	.0017	.0017	.0018	.0018	.0019
T03	0.064	0.067	0.072	0.075	0.077	0.080	0.081	0.085	0.085	0.088	0.089	0.093	0.094
	.0025	.0026	.0028	.0030	.0030	.0031	.0032	.0033	.0033	.0035	.0035	.0037	.0037

Velocità di taglio consigliate

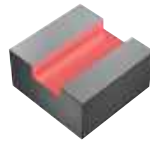
Ottimizzata - Fresa a candela in metallo duro integrale CoroMill® Plura per fresatura multioperazione stabile in HRSA

												
$a_e = 1.0 \times DC$	$a_e = 0.5 \times DC$	$a_e = 0.25 \times DC$										
$a_p = 0.5 \times DC$	$a_p = 1.0 \times DC$	$a_p = 2.0 \times DC$										
ISO	Codice MC	Materiale	HB	f_z	v_c m/min	v_c piedi/min	f_z	v_c m/min	v_c piedi/min	f_z	v_c m/min	v_c piedi/min
S	S1.0.U.AN	Superleghe a base di ferro	200	Z01	30	98	Z01	35	115	Z04	40	131
	S2.0.Z.AN	Superleghe a base di nichel	250	Z02	22	72	Z02	28	92	Z05	30	98
	S2.0.Z.AG	Superleghe a base di nichel	400	Z03	17	56	Z03	22	72	Z06	25	82
	S3.0.Z.AN	Superleghe a base di cobalto	200	Z01	25	82	Z01	30	98	Z04	35	115

Avanzamenti consigliati

mm/dente

pollici/dente

D_c	2.000	3.000	4.000	5.000	6.000	6.350	8.000	9.525	10.000	12.000	12.700	15.875	16.000	19.050	20.000
f_z	0.0787	0.1181	0.157	0.197	0.236	0.250	0.315	0.375	0.394	0.472	0.500	0.625	0.630	0.750	0.787
Z01	0.005 .0002	0.008 .0002	0.011 .0004	0.014 .0005	0.016 .0006	0.017 .0007	0.022 .0009	0.026 .0010	0.027 .0011	0.0325 .0013	0.0330 .0013	0.0365 .0014	0.0366 .0014	0.0387 .0015	0.0393 .0015
Z02	0.005 .0002	0.008 .0003	0.010 .0004	0.013 .0005	0.015 .0006	0.016 .0006	0.020 .0008	0.024 .0009	0.025 .0010	0.0300 .0012	0.0305 .0012	0.0337 .0013	0.0338 .0013	0.0357 .0014	0.0363 .0014
Z03	0.004 .0002	0.006 .0004	0.008 .0003	0.010 .0004	0.013 .0005	0.013 .0005	0.017 .0007	0.020 .0008	0.021 .0008	0.0250 .0010	0.0254 .0010	0.0281 .0011	0.0281 .0011	0.0298 .0012	0.0302 .0012
Z04	0.007 .0003	0.010 .0005	0.013 .0005	0.016 .0006	0.020 .0008	0.021 .0008	0.026 .0010	0.031 .0012	0.033 .0013	0.0390 .0015	0.041 .0016	0.052 .0020	0.052 .0020	0.062 .0024	0.065 .0026
Z05	0.006 .0002	0.009 .0004	0.012 .0005	0.015 .0006	0.018 .0007	0.019 .0008	0.024 .0009	0.029 .0011	0.030 .0012	0.0360 .0014	0.038 .0015	0.048 .0019	0.048 .0019	0.057 .0023	0.060 .0024
Z06	0.006 .0002	0.009 .0006	0.012 .0005	0.015 .0006	0.018 .0007	0.019 .0007	0.023 .0009	0.028 .0011	0.029 .0011	0.035 .0014	0.037 .0015	0.046 .0018	0.047 .0018	0.056 .0022	0.058 .0023

Foratura

Punte ad inserti multitaglienti

CoroDrill® DS20

C2-C5

Dati di taglio

C6

Per informazioni sulla gamma completa, visitare il sito www.sandvik.coromant.com/it

Punta a inserti multitaglienti CoroDrill® DS20

Attacco cilindrico con piano parallelo secondo ISO 9766

Adduzione interna di refrigerante

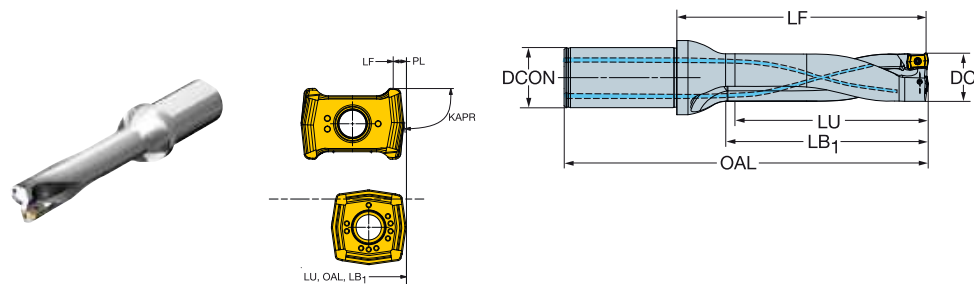

Dimensioni in mm

										Dimensioni, millimetri									
DC	LU	CZC _{MS}	ADJLX	TCHAL	TCHAU	Codice di ordinazione	DCON _{MS}	LF	OAL	LB ₁	PL	KAPR	BAR	NM	KG	RPMX			
01C	01P	15.50	62.46	20	1.00	0.00	0.27	DS20-D1550L20-04	20.00	82.53	131.00	63.00	0.46	81°	10	0.6	0.193	24000	
			77.96	20	1.00	0.00	0.27	DS20-D1550L20-05	20.00	95.53	146.00	78.00	0.46	81°	10	0.6	0.205	15000	
01C	01P	16.50	66.46	20	0.75	0.00	0.27	DS20-D1650L20-04	20.00	84.53	135.00	67.00	0.46	81°	10	0.6	0.203	22000	
			82.96	20	0.75	0.00	0.27	DS20-D1650L20-05	20.00	100.53	151.00	83.00	0.46	81°	10	0.6	0.217	14000	
01C	01P	17.50	70.46	25	0.50	0.00	0.27	DS20-D1750L25-04	25.00	94.53	151.00	73.00	0.46	81°	10	0.6	0.337	21000	
			85.46	25	0.50	0.00	0.27	DS20-D1750L25-05	25.00	105.53	156.00	88.00	0.46	81°	10	0.6	0.353	13000	
01C	01P	18.50	72.46	25	0.25	0.00	0.27	DS20-D1850L25-04	25.00	96.53	153.00	75.00	0.46	81°	10	0.6	0.349	20000	
			92.96	25	0.25	0.00	0.27	DS20-D1850L25-05	25.00	114.53	171.00	93.00	0.46	81°	10	0.6	0.368	13000	
02C	02P	19.50	78.55	25	1.06	0.00	0.33	DS20-D1950L25-04	25.00	100.44	157.00	79.00	0.55	81°	10	0.9	0.362	19000	
			98.05	25	1.06	0.00	0.33	DS20-D1950L25-05	25.00	119.44	176.00	98.00	0.55	81°	10	0.9	0.385	12000	
06C	06P	41.00	164.00	40	3.73	0.00	0.35	DS20-D4100L40-04	40.00	197.72	269.00	169.00	1.27	81°	10	3.0	1.750	9000	
			205.00	40	3.73	0.00	0.35	DS20-D4100L40-05	40.00	238.72	310.00	210.00	1.27	81°	10	3.0	1.961	5000	
			246.00	40	3.73	-0.10	0.40	DS20-D4100L40-06	40.00	279.72	351.00	251.00	1.27	81°	10	3.0	2.172	4000	
			287.00	40	3.73	-0.10	0.40	DS20-D4100L40-07	40.00	320.72	392.00	292.00	1.27	81°	10	3.0	2.383	3000	
06C	06P	42.00	168.00	50	3.46	0.00	0.35	DS20-D4200L50-04	50.00	208.72	290.00	173.00	1.27	81°	10	3.0	2.578	8000	
			210.00	50	3.46	0.00	0.35	DS20-D4200L50-05	50.00	250.72	332.00	215.00	1.27	81°	10	3.0	2.805	5000	
			252.00	50	3.46	-0.10	0.40	DS20-D4200L50-06	50.00	292.72	374.00	257.00	1.27	81°	10	3.0	3.033	4000	
			294.00	50	3.46	-0.10	0.40	DS20-D4200L50-07	50.00	334.72	416.00	299.00	1.27	81°	10	3.0	3.260	2000	
06C	06P	43.00	172.00	50	3.19	0.00	0.35	DS20-D4300L50-04	50.00	212.72	294.00	177.00	1.27	81°	10	3.0	2.654	8000	
			215.00	50	3.19	0.00	0.35	DS20-D4300L50-05	50.00	255.72	337.00	220.00	1.27	81°	10	3.0	2.898	5000	
			258.00	50	3.19	-0.10	0.40	DS20-D4300L50-06	50.00	298.72	380.00	263.00	1.27	81°	10	3.0	3.143	3000	
			301.00	50	3.19	-0.10	0.40	DS20-D4300L50-07	50.00	341.72	423.00	306.00	1.27	81°	10	3.0	3.388	2000	
06C	06P	44.00	176.00	50	2.92	0.00	0.35	DS20-D4400L50-04	50.00	216.72	298.00	181.00	1.27	81°	10	3.0	2.733	8000	
			220.00	50	2.92	0.00	0.35	DS20-D4400L50-05	50.00	260.72	342.00	225.00	1.27	81°	10	3.0	2.996	5000	
			264.00	50	2.92	-0.10	0.40	DS20-D4400L50-06	50.00	304.72	386.00	269.00	1.27	81°	10	3.0	3.259	3000	
			308.00	50	2.92	-0.10	0.40	DS20-D4400L50-07	50.00	348.72	430.00	313.00	1.27	81°	10	3.0	3.521	2000	
06C	06P	45.00	180.00	50	2.65	0.00	0.35	DS20-D4500L50-04	50.00	220.72	302.00	185.00	1.27	81°	10	3.0	2.816	8000	
			225.00	50	2.65	0.00	0.35	DS20-D4500L50-05	50.00	265.72	347.00	230.00	1.27	81°	10	3.0	3.101	5000	
			270.00	50	2.65	-0.10	0.40	DS20-D4500L50-06	50.00	310.72	392.00	275.00	1.27	81°	10	3.0	3.385	3000	
			315.00	50	2.65	-0.10	0.40	DS20-D4500L50-07	50.00	355.72	437.00	320.00	1.27	81°	10	3.0	3.669	2000	
06C	06P	46.00	184.00	50	2.38	0.00	0.35	DS20-D4600L50-04	50.00	224.72	306.00	189.00	1.27	81°	10	3.0	2.902	8000	
			230.00	50	2.38	0.00	0.35	DS20-D4600L50-05	50.00	270.72	352.00	235.00	1.27	81°	10	3.0	3.206	5000	
06C	06P	47.00	188.00	50	2.11	0.00	0.35	DS20-D4700L50-04	50.00	227.72	309.00	193.00	1.27	81°	10	3.0	2.968	8000	
			235.00	50	2.11	0.00	0.35	DS20-D4700L50-05	50.00	274.72	356.00	240.00	1.27	81°	10	3.0	3.293	5000	
06C	06P	48.00	192.00	50	1.84	0.00	0.35	DS20-D4800L50-04	50.00	231.72	313.00	197.00	1.27	81°	10	3.0	3.061	7000	
			240.00	50	1.84	0.00	0.35	DS20-D4800L50-05	50.00	279.72	361.00	245.00	1.27	81°	10	3.0	3.408	5000	
06C	06P	49.00	196.00	50	1.57	0.00	0.35	DS20-D4900L50-04	50.00	235.72	317.00	201.00	1.27	81°	10	3.0	3.158	7000	
			245.00	50	1.57	0.00	0.35	DS20-D4900L50-05	50.00	284.72	366.00	250.00	1.27	81°	10	3.0	3.528	4000	
06C	06P	50.00	200.00	50	1.30	0.00	0.35	DS20-D5000L50-04	50.00	239.72	321.00	205.00	1.27	81°	10	3.0	3.259	7000	
			250.00	50	1.30	0.00	0.35	DS20-D5000L50-05	50.00	289.72	371.00	255.00	1.27	81°	10	3.0	3.652	4000	

	Parti di ricambio
DC	Vite per inserto
15.50-18.50	5513 020-27
19.50	5513 020-88
41.00-65.00	416.1-834

Per l'elenco completo delle parti di ricambio, accedere a www.sandvik.coromant.com



C5



F2



F5

Punta a inserti multitaglienti CoroDrill® DS20

Attacco cilindrico con piano parallelo secondo ISO 9766

Adduzione interna di refrigerante

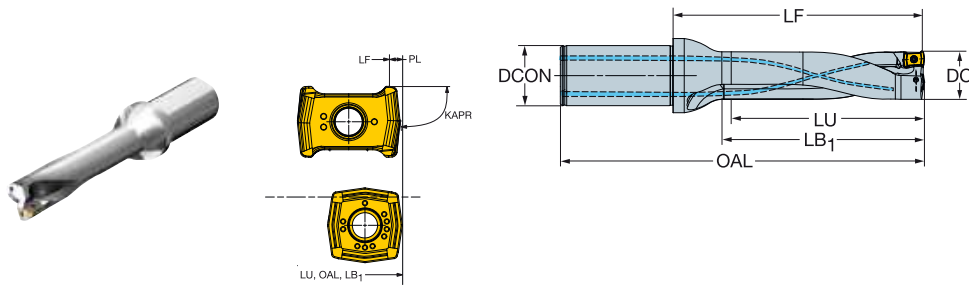

Dimensioni in mm

		Dimensioni, millimetri																
DC	LU	CZC _{MS}	ADJLX	TCHAL	TCHAU	Codice di ordinazione	DCON _{MS}	LF	OAL	LB ₁	PL	KAPR	BAR	NM	KG	RPMX		
06C	06P	51.00	204.00	50	1.03	0.00	0.35	DS20-D5100L50-04	50.00	243.72	325.00	209.00	1.27	81°	10	3.0	3.363	7000
		255.00	50	1.03	0.00	0.35	DS20-D5100L50-05	50.00	294.72	376.00	260.00	1.27	81°	10	3.0	3.781	4000	
06C	06P	52.00	208.00	50	0.76	0.00	0.35	DS20-D5200L50-04	50.00	247.72	329.00	213.00	1.27	81°	10	3.0	3.472	7000
		260.00	50	0.76	0.00	0.35	DS20-D5200L50-05	50.00	299.72	381.00	265.00	1.27	81°	10	3.0	3.916	4000	
07C	07P	53.00	212.00	50	4.21	0.00	0.35	DS20-D5300L50-04	50.00	251.41	333.00	217.00	1.58	81°	10	3.0	3.459	7000
		265.00	50	4.21	0.00	0.35	DS20-D5300L50-05	50.00	304.41	386.00	270.00	1.58	81°	10	3.0	3.911	4000	
07C	07P	54.00	216.00	50	3.92	0.00	0.35	DS20-D5400L50-04	50.00	255.41	337.00	221.00	1.58	81°	10	3.0	3.573	7000
		270.00	50	3.92	0.00	0.35	DS20-D5400L50-05	50.00	309.41	391.00	275.00	1.58	81°	10	3.0	4.052	4000	
07C	07P	55.00	220.00	50	3.63	0.00	0.35	DS20-D5500L50-04	50.00	259.41	341.00	225.00	1.58	81°	10	3.0	3.694	6000
		275.00	50	3.63	0.00	0.35	DS20-D5500L50-05	50.00	314.41	396.00	280.00	1.58	81°	10	3.0	4.202	4000	
07C	07P	56.00	224.00	50	3.34	0.00	0.35	DS20-D5600L50-04	50.00	263.41	345.00	229.00	1.58	81°	10	3.0	3.827	6000
		280.00	50	3.34	0.00	0.35	DS20-D5600L50-05	50.00	319.41	401.00	285.00	1.58	81°	10	3.0	4.367	4000	
07C	07P	57.00	228.00	50	3.05	0.00	0.35	DS20-D5700L50-04	50.00	267.41	349.00	233.00	1.58	81°	10	3.0	3.957	6000
		285.00	50	3.05	0.00	0.35	DS20-D5700L50-05	50.00	324.41	406.00	290.00	1.58	81°	10	3.0	4.528	4000	
07C	07P	58.00	232.00	50	2.76	0.00	0.35	DS20-D5800L50-04	50.00	271.41	353.00	237.00	1.58	81°	10	3.0	4.300	6000
		290.00	50	2.76	0.00	0.35	DS20-D5800L50-05	50.00	329.41	411.00	295.00	1.58	81°	10	3.0	4.823	4000	
07C	07P	59.00	236.00	50	2.47	0.00	0.35	DS20-D5900L50-04	50.00	274.41	356.00	241.00	1.58	81°	10	3.0	4.146	6000
		295.00	50	2.47	0.00	0.35	DS20-D5900L50-05	50.00	333.41	415.00	300.00	1.58	81°	10	3.0	4.768	4000	
07C	07P	60.00	240.00	50	2.18	0.00	0.35	DS20-D6000L50-04	50.00	278.41	360.00	245.00	1.58	81°	10	3.0	4.350	6000
		300.00	50	2.18	0.00	0.35	DS20-D6000L50-05	50.00	338.41	420.00	305.00	1.58	81°	10	3.0	5.021	4000	
07C	07P	61.00	244.00	50	1.89	0.00	0.35	DS20-D6100L50-04	50.00	282.41	364.00	249.00	1.58	81°	10	3.0	4.498	6000
		305.00	50	1.89	0.00	0.35	DS20-D6100L50-05	50.00	343.41	425.00	310.00	1.58	81°	10	3.0	5.204	4000	
07C	07P	62.00	248.00	50	1.60	0.00	0.35	DS20-D6200L50-04	50.00	286.41	368.00	253.00	1.58	81°	10	3.0	4.651	6000
		310.00	50	1.60	0.00	0.35	DS20-D6200L50-05	50.00	348.41	430.00	315.00	1.58	81°	10	3.0	5.393	3000	
07C	07P	63.00	252.00	50	1.31	0.00	0.35	DS20-D6300L50-04	50.00	290.41	372.00	257.00	1.58	81°	10	3.0	4.806	6000
		315.00	50	1.31	0.00	0.35	DS20-D6300L50-05	50.00	353.41	435.00	320.00	1.58	81°	10	3.0	5.587	3000	
07C	07P	64.00	256.00	50	1.02	0.00	0.35	DS20-D6400L50-04	50.00	295.41	377.00	261.00	1.58	81°	10	3.0	4.848	5000
		320.00	50	1.02	0.00	0.35	DS20-D6400L50-05	50.00	359.41	441.00	325.00	1.58	81°	10	3.0	5.633	3000	
07C	07P	65.00	260.00	50	0.73	0.00	0.35	DS20-D6500L50-04	50.00	299.41	381.00	265.00	1.58	81°	10	3.0	5.167	5000
		325.00	50	0.73	0.00	0.35	DS20-D6500L50-05	50.00	364.41	446.00	330.00	1.58	81°	10	3.0	6.027	3000	

Parti di ricambio	
DC	Vite per inserto
15.50-18.50	5513 020-27
19.50	5513 020-88
41.00-65.00	416.1-834

Per l'elenco completo delle parti di ricambio, accedere a www.sandvik.coromant.com

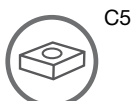

Punta a inserti multitaglienti CoroDrill® DS20

Attacco cilindrico con piano parallelo secondo ISO 9766

Adduzione interna di refrigerante

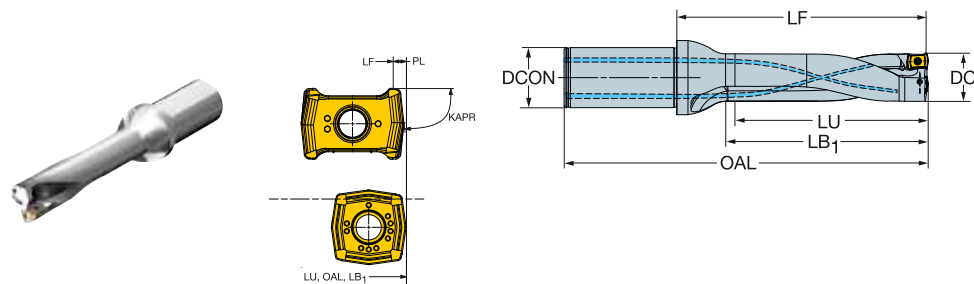

Dimensioni in pollici

		Dimensioni, pollici															
DC	LU	CZC _{MS}	ADJLX	TCHAL	TCHAU	Codice di ordinazione	DCON _{MS}	LF	OAL	LB ₁	PL	KAPR	PSI	FT/LBS	LBS	RPMX	
06C	06P	1.625	6.500	1 1/2	.143	.000	DS20-D4128LX38-04	1.500	7.770	10.576	6.666	.050	81°	145	2.2	3.968	9000
		8.125	1 1/2	.143	.000	.014	DS20-D4128LX38-05	1.500	9.395	12.201	8.291	.050	81°	145	2.2	4.409	5000
		9.750	1 1/2	.143	-.004	.016	DS20-D4128LX38-06	1.500	11.020	13.826	9.916	.050	81°	145	2.2	5.511	4000
		11.375	1 1/2	.143	-.004	.016	DS20-D4128LX38-07	1.500	12.645	15.451	11.541	.050	81°	145	2.2	5.952	3000
06C	06P	1.687	6.748	1 1/2	.127	.000	DS20-D4285LX38-04	1.500	8.013	10.819	6.914	.050	81°	145	2.2	4.409	8000
		8.435	1 1/2	.127	.000	.014	DS20-D4285LX38-05	1.500	9.700	12.506	8.601	.050	81°	145	2.2	4.629	5000
		10.122	1 1/2	.127	-.004	.016	DS20-D4285LX38-06	1.500	11.387	14.193	10.288	.050	81°	145	2.2	5.952	3000
		11.809	1 1/2	.127	-.004	.016	DS20-D4285LX38-07	1.500	13.074	15.880	11.975	.050	81°	145	2.2	6.393	2000
06C	06P	1.750	7.000	1 1/2	.110	.000	DS20-D4445LX38-04	1.500	8.260	11.066	7.166	.050	81°	145	2.2	4.409	8000
		8.750	1 1/2	.110	.000	.014	DS20-D4445LX38-05	1.500	10.010	12.816	8.916	.050	81°	145	2.2	4.841	5000
		10.500	1 1/2	.110	-.004	.016	DS20-D4445LX38-06	1.500	11.760	14.566	10.666	.050	81°	145	2.2	6.172	3000
		12.250	1 1/2	.110	-.004	.016	DS20-D4445LX38-07	1.500	13.510	16.316	12.416	.050	81°	145	2.2	6.038	2000
06C	06P	1.875	7.500	1 1/2	.076	.000	DS20-D4763LX38-04	1.500	8.750	11.556	7.666	.050	81°	145	2.2	5.070	7000
		9.375	1 1/2	.076	.000	.014	DS20-D4763LX38-05	1.500	10.625	13.431	9.541	.050	81°	145	2.2	6.393	5000
06C	06P	2.000	8.000	1 1/2	.042	.000	DS20-D5080LX38-04	1.500	9.520	12.326	8.166	.050	81°	145	2.2	6.172	7000
		10.000	1 1/2	.042	.000	.014	DS20-D5080LX38-05	1.500	11.520	14.326	10.166	.050	81°	145	2.2	7.716	4000
07C	07P	2.125	8.500	1 1/2	.154	.000	DS20-D5398LX38-04	1.500	10.009	12.828	8.678	.063	81°	145	2.2	6.530	7000
		10.625	1 1/2	.154	.000	.014	DS20-D5398LX38-05	1.500	12.134	14.953	10.803	.063	81°	145	2.2	8.377	4000
07C	07P	2.250	9.000	1 1/2	.118	.000	DS20-D5715LX38-04	1.500	10.499	13.318	9.178	.063	81°	145	2.2	7.414	6000
		11.250	1 1/2	.118	.000	.014	DS20-D5715LX38-05	1.500	12.749	15.568	11.428	.063	81°	145	2.2	9.259	4000
07C	07P	2.375	9.500	1 1/2	.082	.000	DS20-D6033LX38-04	1.500	10.989	13.808	9.678	.063	81°	145	2.2	8.377	6000
		11.875	1 1/2	.082	.000	.014	DS20-D6033LX38-05	1.500	13.364	16.183	12.053	.063	81°	145	2.2	10.582	4000
07C	07P	2.500	10.000	1 1/2	.045	.000	DS20-D6350LX38-04	1.500	11.480	14.299	10.178	.063	81°	145	2.2	9.389	6000
		12.500	1 1/2	.045	.000	.014	DS20-D6350LX38-05	1.500	13.980	16.799	12.678	.063	81°	145	2.2	11.905	3000

Parti di ricambio

Vite per inserto
416.1-834

Per l'elenco completo delle parti di ricambio, accedere a www.sandvik.coromant.com

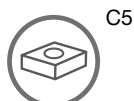

Inserto per foratura CoroDrill® DS20

Inserto centrale

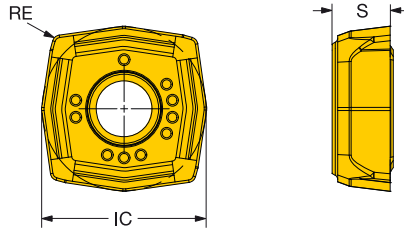

INSUC	Codice di ordinazione	Dimensioni in mm e pollici										
		P	M	K	N	S	H					
06	C	DS20-0608-C-L5	★	★	★	★	★	★	S	RE	IC	
			1344	1144	1344	H13A	1344	H13A	1344	3.90	0.35	17.5
										.154	.014	.687
06	C	DS20-0608-C-M7	★	★				☆		3.90	0.35	17.5
										.154	.014	.687
07	C	DS20-0708-C-L5	★	★	★	☆	★	★	★	4.50	0.35	21.8
										.177	.014	.859
07	C	DS20-0708-C-M7	★	★				☆		4.50	0.35	21.8
										.177	.014	.859

Inserto periferico

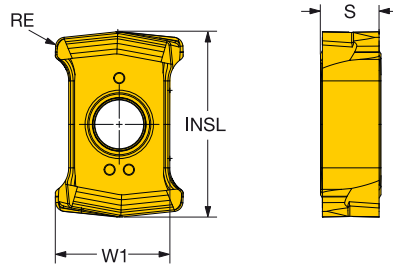

INSUC	Codice di ordinazione	Dimensioni in mm e pollici													
		P	M	K	N	S	H	S	RE	W1	INSL				
06	P	DS20-0608-P-H5W	★	★	★	★	★	★	★	★	★	6.20	0.80	14.4	19.4
			4324	4334	4344	2044	4334	4344	4324	4334	4344				
06	P	DS20-0608-P-L5W	☆	★	★	★	★	★	★	★	★	6.20	0.80	14.4	19.4
06	P	DS20-0608-P-L6W		★		★	★	★	★	★	★	6.20	0.80	14.4	19.4
06	P	DS20-0608-P-M7W	☆	★	☆		☆	★	☆		☆	6.20	0.80	14.4	19.4
06	P	DS20-0608-P-S5W				★		☆	★	☆		6.20	0.80	14.4	19.4
07	P	DS20-0708-P-H5W		★	★	★	★					7.00	0.80	18.0	21.9
07	P	DS20-0708-P-L5W	☆	★	★	★	★	★	★	☆		7.00	0.80	18.0	21.9
07	P	DS20-0708-P-L6W		★		★	★	★	★	★	★	7.00	0.80	18.0	21.9
07	P	DS20-0708-P-M7W	☆	★	☆		☆	★	☆		☆	7.00	0.80	18.0	21.9
07	P	DS20-0708-P-S5W				★		☆	★	☆		7.00	0.80	18.0	21.9



C2



C6



F2

CoroDrill® DS20

4-5xD

Valori in millimetri

ISO	Codice MC	Materiale	HB	Qualità	Velocità di taglio consigliate			Diametro punta	Lunghezza della punta 4xD					Lunghezza della punta 5xD					
									-S5W	-L5W	-L6W	-M7W	-H5W	-S5W	-L5W	-L6W	-M7W	-H5W	
					4-5xD				Valore iniziale raccomandato a metà del campo di avanzamento										
P	P3.0.Z.HT	Acciaio fortemente legato Temprato	380	4324	80	165	210	15.00-18.00	-	-	0.06-0.14	0.06-0.16	-	-	-	0.06-0.12	0.06-0.14	-	
				4334	75	140	175	18.01-22.00	-	-	0.06-0.16	0.06-0.18	-	-	-	0.06-0.14	0.06-0.15	-	
				4344	70	110	130	22.01-27.00	-	-	0.06-0.2	0.06-0.22	-	-	-	0.06-0.17	0.06-0.19	-	
			200	Acciaio inossidabile ferritico/martensitico Ricotto	4334	115	185	225	15.00-18.00	0.05-0.13	0.05-0.13	0.05-0.13	-	0.05-0.12	0.05-0.11	0.05-0.11	0.05-0.11	-	0.05-0.1
					4344	115	155	175	18.01-22.00	0.05-0.14	0.05-0.14	0.05-0.14	-	0.05-0.13	0.05-0.12	0.05-0.12	0.05-0.12	-	0.05-0.11
					2044	115	150	165	22.01-27.00	0.05-0.15	0.05-0.15	0.05-0.15	-	0.05-0.14	0.05-0.13	0.05-0.13	0.05-0.13	-	0.05-0.12
	330	Acciaio inossidabile ferritico/martensitico Temprato	4334	75	135	170	15.00-18.00	0.05-0.13	0.05-0.13	0.05-0.13	-	0.05-0.12	0.05-0.11	0.05-0.11	0.05-0.11	-	0.05-0.1		
			4344	70	115	140	18.01-22.00	0.05-0.14	0.05-0.14	0.05-0.14	-	0.05-0.13	0.05-0.12	0.05-0.12	0.05-0.12	-	0.05-0.11		
			2044	70	115	140	22.01-27.00	0.05-0.15	0.05-0.15	0.05-0.15	-	0.05-0.14	0.05-0.13	0.05-0.13	0.05-0.13	-	0.05-0.12		
			200	Acciaio inossidabile duplex >60% ferrite (N<0.10%)	4334	85	125	145	15.00-18.00	0.05-0.12	0.05-0.12	0.05-0.12	-	0.05-0.11	0.05-0.11	0.05-0.11	0.05-0.11	-	0.05-0.1
					4344	85	115	130	18.01-22.00	0.05-0.13	0.05-0.13	0.05-0.13	-	0.05-0.12	0.05-0.12	0.05-0.12	0.05-0.12	-	0.05-0.11
					2044	85	110	125	22.01-27.00	0.05-0.14	0.05-0.14	0.05-0.14	-	0.05-0.13	0.05-0.13	0.05-0.13	0.05-0.13	-	0.05-0.12
260	Acciaio inossidabile duplex <Ferrite al 60% (N>0.10%)	4334	75	105	120	15.00-18.00	0.05-0.12	0.05-0.12	0.05-0.12	-	0.05-0.11	0.05-0.11	0.05-0.11	0.05-0.11	-	0.05-0.1			
		4344	75	100	115	18.01-22.00	0.05-0.13	0.05-0.13	0.05-0.13	-	0.05-0.12	0.05-0.12	0.05-0.12	0.05-0.12	-	0.05-0.11			
		2044	75	100	115	22.01-27.00	0.05-0.14	0.05-0.14	0.05-0.14	-	0.05-0.13	0.05-0.13	0.05-0.13	0.05-0.13	-	0.05-0.12			
		350	Superleghe resistenti al calore Base Ni	4334	20	40	50	15.00-18.00	0.04-0.08	0.04-0.08	0.04-0.08	-	-	0.04-0.07	0.04-0.07	0.04-0.07	-	-	
				4344	20	40	50	18.01-22.00	0.04-0.09	0.04-0.09	0.04-0.09	-	-	0.04-0.08	0.04-0.08	0.04-0.08	-	-	
				2044	20	40	50	22.01-27.00	0.04-0.1	0.04-0.1	0.04-0.1	-	-	0.04-0.09	0.04-0.09	0.04-0.09	-	-	
330	Superleghe resistenti al calore Base Ti	4334	40	90	120	15.00-18.00	0.06-0.14	0.06-0.14	0.06-0.14	-	-	0.06-0.12	0.06-0.12	0.06-0.12	-	-			
		4344	40	90	120	18.01-22.00	0.06-0.15	0.06-0.15	0.06-0.15	-	-	0.06-0.13	0.06-0.13	0.06-0.13	-	-			
		2044	40	90	120	22.01-27.00	0.06-0.16	0.06-0.16	0.06-0.16	-	-	0.06-0.14	0.06-0.14	0.06-0.14	-	-			
		350	Superleghe resistenti al calore Base Ti	4334	20	40	50	15.00-18.00	0.04-0.08	0.04-0.08	0.04-0.08	-	-	0.04-0.07	0.04-0.07	0.04-0.07	-	-	
				4344	20	40	50	18.01-22.00	0.04-0.09	0.04-0.09	0.04-0.09	-	-	0.04-0.08	0.04-0.08	0.04-0.08	-	-	
				2044	20	40	50	22.01-27.00	0.04-0.1	0.04-0.1	0.04-0.1	-	-	0.04-0.09	0.04-0.09	0.04-0.09	-	-	
350	Superleghe resistenti al calore Base Ni	4334	20	40	50	15.00-18.00	0.04-0.08	0.04-0.08	0.04-0.08	-	-	0.04-0.07	0.04-0.07	0.04-0.07	-	-			
		4344	20	40	50	18.01-22.00	0.04-0.09	0.04-0.09	0.04-0.09	-	-	0.04-0.08	0.04-0.08	0.04-0.08	-	-			
		2044	20	40	50	22.01-27.00	0.04-0.1	0.04-0.1	0.04-0.1	-	-	0.04-0.09	0.04-0.09	0.04-0.09	-	-			
		350	Superleghe resistenti al calore Base Ni	4334	20	40	50	15.00-18.00	0.04-0.08	0.04-0.08	0.04-0.08	-	-	0.04-0.07	0.04-0.07	0.04-0.07	-	-	
				4344	20	40	50	18.01-22.00	0.04-0.09	0.04-0.09	0.04-0.09	-	-	0.04-0.08	0.04-0.08	0.04-0.08	-	-	
				2044	20	40	50	22.01-27.00	0.04-0.1	0.04-0.1	0.04-0.1	-	-	0.04-0.09	0.04-0.09	0.04-0.09	-	-	

CoroDrill® DS20

4-5xD

Valori in millimetri

ISO	Codice MC	Materiale	HB	Qualità	Velocità di taglio consigliate			Diametro punta	Lunghezza della punta 4xD					Lunghezza della punta 5xD				
									-S5W	-L5W	-L6W	-M7W	-H5W	-S5W	-L5W	-L6W	-M7W	-H5W
					4-5xD			Valore iniziale raccomandato a metà del campo di avanzamento										
K	K1.1.C.NS	Ghisa malleabile Bassa resistenza	200	4324	140	210	245	15.00-18.00	-	0.08-0.15	0.08-0.15	0.08-0.2	-	-	0.08-0.13	0.08-0.13	0.08-0.17	-
				4334	110	170	200	18.01-22.00	-	0.08-0.18	0.08-0.18	0.08-0.23	-	-	0.08-0.15	0.08-0.15	0.08-0.2	-
				4344	180	165	155	22.01-27.00	-	0.08-0.21	0.08-0.21	0.08-0.26	-	-	0.08-0.18	0.08-0.18	0.08-0.22	-
								27.01-33.00	-	0.1-0.24	0.1-0.24	0.1-0.29	-	-	0.1-0.2	0.1-0.2	0.1-0.25	-
								33.01-40.00	-	0.1-0.27	0.1-0.27	0.1-0.32	-	-	0.1-0.23	0.1-0.23	0.1-0.27	-
								40.01-52.00	-	0.12-0.27	0.12-0.27	0.12-0.32	-	-	0.12-0.23	0.12-0.23	0.12-0.27	-
								52.01-65.00	-	0.12-0.27	0.12-0.27	0.12-0.32	-	-	0.12-0.23	0.12-0.23	0.12-0.27	-
	K2.1.C.UT	Ghisa grigia Bassa resistenza	180	4324	210	285	325	15.00-18.00	-	0.08-0.15	0.08-0.15	0.08-0.2	-	-	0.08-0.13	0.08-0.13	0.08-0.17	-
				4334	170	235	270	18.01-22.00	-	0.08-0.18	0.08-0.18	0.08-0.23	-	-	0.08-0.15	0.08-0.15	0.08-0.2	-
				4344	130	180	205	22.01-27.00	-	0.08-0.21	0.08-0.21	0.08-0.26	-	-	0.08-0.18	0.08-0.18	0.08-0.22	-
								27.01-33.00	-	0.1-0.24	0.1-0.24	0.1-0.29	-	-	0.1-0.2	0.1-0.2	0.1-0.25	-
								33.01-40.00	-	0.1-0.27	0.1-0.27	0.1-0.32	-	-	0.1-0.23	0.1-0.23	0.1-0.27	-
								40.01-52.00	-	0.12-0.27	0.12-0.27	0.12-0.32	-	-	0.12-0.23	0.12-0.23	0.12-0.27	-
								52.01-65.00	-	0.12-0.27	0.12-0.27	0.12-0.32	-	-	0.12-0.23	0.12-0.23	0.12-0.27	-
	K2.2.C.UT	Ghisa grigia Alta resistenza	245	4324	125	205	245	15.00-18.00	-	0.08-0.13	0.08-0.13	0.08-0.18	-	-	0.08-0.11	0.08-0.11	0.08-0.15	-
				4334	100	160	195	18.01-22.00	-	0.08-0.16	0.08-0.16	0.08-0.21	-	-	0.08-0.14	0.08-0.14	0.08-0.18	-
				4344	75	125	150	22.01-27.00	-	0.08-0.19	0.08-0.19	0.08-0.24	-	-	0.08-0.16	0.08-0.16	0.08-0.2	-
								27.01-33.00	-	0.1-0.22	0.1-0.22	0.1-0.27	-	-	0.1-0.19	0.1-0.19	0.1-0.23	-
								33.01-40.00	-	0.1-0.25	0.1-0.25	0.1-0.3	-	-	0.1-0.21	0.1-0.21	0.1-0.26	-
								40.01-52.00	-	0.12-0.25	0.12-0.25	0.12-0.3	-	-	0.12-0.21	0.12-0.21	0.12-0.26	-
								52.01-65.00	-	0.12-0.25	0.12-0.25	0.12-0.3	-	-	0.12-0.21	0.12-0.21	0.12-0.26	-
	K3.1.C.UT	Ghisa nodulare Ferritica	155	4324	125	190	225	15.00-18.00	-	0.08-0.13	0.08-0.13	0.08-0.18	-	-	0.08-0.11	0.08-0.11	0.08-0.15	-
				4334	100	155	185	18.01-22.00	-	0.08-0.16	0.08-0.16	0.08-0.21	-	-	0.08-0.14	0.08-0.14	0.08-0.18	-
				4344	80	120	145	22.01-27.00	-	0.08-0.19	0.08-0.19	0.08-0.24	-	-	0.08-0.16	0.08-0.16	0.08-0.2	-
							27.01-33.00	-	0.1-0.22	0.1-0.22	0.1-0.27	-	-	0.1-0.19	0.1-0.19	0.1-0.23	-	
							33.01-40.00	-	0.1-0.25	0.1-0.25	0.1-0.3	-	-	0.1-0.21	0.1-0.21	0.1-0.26	-	
							40.01-52.00	-	0.12-0.25	0.12-0.25	0.12-0.3	-	-	0.12-0.21	0.12-0.21	0.12-0.26	-	
							52.01-65.00	-	0.12-0.25	0.12-0.25	0.12-0.3	-	-	0.12-0.21	0.12-0.21	0.12-0.26	-	
K3.3.C.UT	Ghisa nodulare Perlitica	265	4324	110	175	210	15.00-18.00	-	0.08-0.13	0.08-0.13	0.08-0.18	-	-	0.08-0.11	0.08-0.11	0.08-0.15	-	
			4334	90	145	175	18.01-22.00	-	0.08-0.16	0.08-0.16	0.08-0.21	-	-	0.08-0.14	0.08-0.14	0.08-0.18	-	
			4344	70	110	130	22.01-27.00	-	0.08-0.19	0.08-0.19	0.08-0.24	-	-	0.08-0.16	0.08-0.16	0.08-0.2	-	
							27.01-33.00	-	0.1-0.22	0.1-0.22	0.1-0.27	-	-	0.1-0.19	0.1-0.19	0.1-0.23	-	
							33.01-40.00	-	0.1-0.25	0.1-0.25	0.1-0.3	-	-	0.1-0.21	0.1-0.21	0.1-0.26	-	
							40.01-52.00	-	0.12-0.25	0.12-0.25	0.12-0.3	-	-	0.12-0.21	0.12-0.21	0.12-0.26	-	
							52.01-65.00	-	0.12-0.25	0.12-0.25	0.12-0.3	-	-	0.12-0.21	0.12-0.21	0.12-0.26	-	
K4.2.C.UT	Ghisa a grafite compatta (CGI) Elevata resistenza alla trazione (Perlite>80%)	230	4324	130	210	250	15.00-18.00	-	0.08-0.13	0.08-0.13	0.08-0.18	-	-	0.08-0.11	0.08-0.11	0.08-0.15	-	
			4334	110	170	200	18.01-22.00	-	0.08-0.16	0.08-0.16	0.08-0.21	-	-	0.08-0.14	0.08-0.14	0.08-0.18	-	
			4344	85	125	150	22.01-27.00	-	0.08-0.19	0.08-0.19	0.08-0.24	-	-	0.08-0.16	0.08-0.16	0.08-0.2	-	
							27.01-33.00	-	0.1-0.22	0.1-0.22	0.1-0.27	-	-	0.1-0.19	0.1-0.19	0.1-0.23	-	
							33.01-40.00	-	0.1-0.25	0.1-0.25	0.1-0.3	-	-	0.1-0.21	0.1-0.21	0.1-0.26	-	
							40.01-52.00	-	0.12-0.25	0.12-0.25	0.12-0.3	-	-	0.12-0.21	0.12-0.21	0.12-0.26	-	
							52.01-65.00	-	0.12-0.25	0.12-0.25	0.12-0.3	-	-	0.12-0.21	0.12-0.21	0.12-0.26	-	
H	H1.3.Z.HA	Acciai extra duri Temprato	60	30	65	85	15.00-18.00	-	0.06-0.13	0.06-0.13	0.06-0.13	-	-	0.06-0.11	0.06-0.11	0.06-0.11	-	
			4324 (HRC)	30	65	85	18.01-22.00	-	0.06-0.14	0.06-0.14	0.06-0.14	-	-	0.06-0.12	0.06-0.12	0.06-0.12	-	
			4334	30	65	85	22.01-27.00	-	0.06-0.15	0.06-0.15	0.06-0.15	-	-	0.06-0.13	0.06-0.13	0.06-0.13	-	
			4344				27.01-33.00	-	0.08-0.16	0.08-0.16	0.08-0.16	-	-	0.08-0.14	0.08-0.14	0.08-0.14	-	
							33.01-40.00	-	0.08-0.18	0.08-0.18	0.08-0.18	-	-	0.08-0.15	0.08-0.15	0.08-0.15	-	
							40.01-52.00	-	0.1-0.18	0.1-0.18	0.1-0.18	-	-	0.1-0.15	0.1-0.15	0.1-0.15	-	
							52.01-65.00	-	0.1-0.18	0.1-0.18	0.1-0.18	-	-	0.1-0.15	0.1-0.15	0.1-0.15	-	

CoroDrill® DS20

4-5xD

Valori in millimetri

ISO	Codice MC	Materiale	HB	Qualità	Velocità di taglio consigliate			Diametro punta	Lunghezza della punta 4xD					Lunghezza della punta 5xD				
									-S5W	-L5W	-L6W	-M7W	-H5W	-S5W	-L5W	-L6W	-M7W	-H5W
									Valore iniziale raccomandato a metà del campo di avanzamento									
4-5xD																		
N	N1.2.Z.AG	Leghe a base di alluminio Leghe AISi, Si ≤ 1%	100	H13A 4344	300	365	400	15.00-18.00	0.06-0.16	0.06-0.16	0.06-0.16	-	-	0.06-0.14	0.06-0.14	0.06-0.14	-	-
								18.01-22.00	0.06-0.18	0.06-0.18	0.06-0.18	-	-	0.06-0.15	0.06-0.15	0.06-0.15	-	-
					22.01-27.00	0.06-0.2	0.06-0.2	0.06-0.2	-	-	0.06-0.17	0.06-0.17	0.06-0.17	-	-			
					27.01-33.00	0.08-0.22	0.08-0.22	0.08-0.22	0.08-0.22	0.08-0.22	0.08-0.19	0.08-0.19	0.08-0.19	-	-			
					33.01-40.00	0.08-0.25	0.08-0.25	0.08-0.25	-	-	0.08-0.21	0.08-0.21	0.08-0.21	-	-			
					40.01-52.00	0.1-0.25	0.1-0.25	0.1-0.25	-	-	0.1-0.21	0.1-0.21	0.1-0.21	-	-			
					52.01-65.00	0.1-0.25	0.1-0.25	0.1-0.25	-	-	0.1-0.21	0.1-0.21	0.1-0.21	-	-			
					N1.3.C.UT	Leghe a base di alluminio Leghe fuse AISi (1% < Si < 13%)	75	H13A 4344	250	350	400	15.00-18.00	0.06-0.14	0.06-0.14	0.06-0.14	-	-	0.06-0.12
	18.01-22.00	0.06-0.16	0.06-0.16	0.06-0.16								-	-	0.06-0.14	0.06-0.14	0.06-0.14	-	-
	22.01-27.00	0.06-0.18	0.06-0.18	0.06-0.18					-	-	0.06-0.15	0.06-0.15	0.06-0.15	-	-			
	27.01-33.00	0.08-0.2	0.08-0.2	0.08-0.2					0.08-0.2	0.08-0.2	0.08-0.17	0.08-0.17	0.08-0.17	-	-			
	33.01-40.00	0.08-0.22	0.08-0.22	0.08-0.22					-	-	0.08-0.19	0.08-0.19	0.08-0.19	-	-			
	40.01-52.00	0.1-0.22	0.1-0.22	0.1-0.22					-	-	0.1-0.19	0.1-0.19	0.1-0.19	-	-			
	52.01-65.00	0.1-0.22	0.1-0.22	0.1-0.22					-	-	0.1-0.19	0.1-0.19	0.1-0.19	-	-			
	N1.3.C.AG	Leghe a base di alluminio AlSi cast and aged alloys (1% < Si < 13%)	90	H13A 4344					250	315	350	15.00-18.00	0.06-0.14	0.06-0.14	0.06-0.14	-	-	0.06-0.12
					18.01-22.00	0.06-0.16	0.06-0.16	0.06-0.16				-	-	0.06-0.14	0.06-0.14	0.06-0.14	-	-
					22.01-27.00	0.06-0.18	0.06-0.18	0.06-0.18	-	-	0.06-0.15	0.06-0.15	0.06-0.15	-	-			
					27.01-33.00	0.08-0.2	0.08-0.2	0.08-0.2	-	-	0.08-0.17	0.08-0.17	0.08-0.17	-	-			
					33.01-40.00	0.08-0.22	0.08-0.22	0.08-0.22	0.08-0.22	0.08-0.22	0.08-0.19	0.08-0.19	0.08-0.19	-	-			
					40.01-52.00	0.1-0.22	0.1-0.22	0.1-0.22	-	-	0.1-0.19	0.1-0.19	0.1-0.19	-	-			
					52.01-65.00	0.1-0.22	0.1-0.22	0.1-0.22	-	-	0.1-0.19	0.1-0.19	0.1-0.19	-	-			
					N3.3.U.UT	Leghe a base di rame Leghe a base di rame a lavorabilità migliorata	110	H13A 4344	250	350	400	15.00-18.00	0.06-0.16	0.06-0.16	0.06-0.16	-	-	0.06-0.14
	18.01-22.00	0.06-0.18	0.06-0.18	0.06-0.18								-	-	0.06-0.15	0.06-0.15	0.06-0.15	-	-
	22.01-27.00	0.06-0.2	0.06-0.2	0.06-0.2					-	-	0.06-0.17	0.06-0.17	0.06-0.17	-	-			
27.01-33.00	0.08-0.22	0.08-0.22	0.08-0.22	-					-	0.08-0.19	0.08-0.19	0.08-0.19	-	-				
33.01-40.00	0.08-0.25	0.08-0.25	0.08-0.25	0.08-0.25					0.08-0.25	0.08-0.21	0.08-0.21	0.08-0.21	-	-				
40.01-52.00	0.1-0.25	0.1-0.25	0.1-0.25	-					-	0.1-0.21	0.1-0.21	0.1-0.21	-	-				
52.01-65.00	0.1-0.25	0.1-0.25	0.1-0.25	-					-	0.1-0.21	0.1-0.21	0.1-0.21	-	-				
N3.2.C.UT	Leghe a base di rame Bronzi e ottoni al piombo (Pb<1%)	90	H13A 4344	180					220	240	15.00-18.00	0.06-0.16	0.06-0.16	0.06-0.16	-	-	0.06-0.14	0.06-0.14
					18.01-22.00	0.06-0.18	0.06-0.18	0.06-0.18			-	-	0.06-0.15	0.06-0.15	0.06-0.15	-	-	
				22.01-27.00	0.06-0.2	0.06-0.2	0.06-0.2	-	-	0.06-0.17	0.06-0.17	0.06-0.17	-	-				
				27.01-33.00	0.08-0.22	0.08-0.22	0.08-0.22	-	-	0.08-0.19	0.08-0.19	0.08-0.19	-	-				
				33.01-40.00	0.08-0.25	0.08-0.25	0.08-0.25	-	-	0.08-0.21	0.08-0.21	0.08-0.21	-	-				
				40.01-52.00	0.1-0.25	0.1-0.25	0.1-0.25	-	-	0.1-0.21	0.1-0.21	0.1-0.21	-	-				
				52.01-65.00	0.1-0.25	0.1-0.25	0.1-0.25	-	-	0.1-0.21	0.1-0.21	0.1-0.21	-	-				

CoroDrill® DS20

6-7xD

Valori in millimetri

ISO	Codice MC	Materiale	HB	Qualità	Velocità di taglio consigliate			Diametro punta	Lunghezza punta 6xD					Lunghezza punta 7xD				
									-S5W	-L5W	-L6W	-M7W	-H5W	-S5W	-L5W	-L6W	-M7W	-H5W
									Valore iniziale raccomandato a metà del campo di avanzamento									
K	K1.1.CNS	Ghisa malleabile Bassa resistenza	200	4324	140	190	220	15.00-18.00	-	0.08-0.1	0.08-0.1	0.08-0.13	-	-	0.08-0.08	0.08-0.08	0.08-0.11	-
				4334	110	155	180	18.01-22.00	-	0.08-0.12	0.08-0.12	0.08-0.15	-	-	0.08-0.1	0.08-0.1	0.08-0.13	-
				4344	180	150	140	22.01-27.00	-	0.08-0.14	0.08-0.14	0.08-0.17	-	-	0.08-0.12	0.08-0.12	0.08-0.14	-
								27.01-33.00	-	0.1-0.16	0.1-0.16	0.1-0.19	-	-	0.1-0.13	0.1-0.13	0.1-0.16	-
								33.01-40.00	-	0.1-0.18	0.1-0.18	0.1-0.21	-	-	0.1-0.15	0.1-0.15	0.1-0.18	-
								40.01-52.00	-	0.12-0.18	0.12-0.18	0.12-0.21	-	-	0.12-0.15	0.12-0.15	0.12-0.18	-
					52.01-65.00	-	0.12-0.18	0.12-0.18	0.12-0.21	-	-	0.12-0.15	0.12-0.15	0.12-0.18	-			
	K2.1.C.UT	Ghisa grigia Bassa resistenza	180	4324	210	255	295	15.00-18.00	-	0.08-0.1	0.08-0.1	0.08-0.13	-	-	0.08-0.08	0.08-0.08	0.08-0.11	-
				4334	170	210	245	18.01-22.00	-	0.08-0.12	0.08-0.12	0.08-0.15	-	-	0.08-0.1	0.08-0.1	0.08-0.13	-
				4344	130	160	185	22.01-27.00	-	0.08-0.14	0.08-0.14	0.08-0.17	-	-	0.08-0.12	0.08-0.12	0.08-0.14	-
								27.01-33.00	-	0.1-0.16	0.1-0.16	0.1-0.19	-	-	0.1-0.13	0.1-0.13	0.1-0.16	-
								33.01-40.00	-	0.1-0.18	0.1-0.18	0.1-0.21	-	-	0.1-0.15	0.1-0.15	0.1-0.18	-
								40.01-52.00	-	0.12-0.18	0.12-0.18	0.12-0.21	-	-	0.12-0.15	0.12-0.15	0.12-0.18	-
					52.01-65.00	-	0.12-0.18	0.12-0.18	0.12-0.21	-	-	0.12-0.15	0.12-0.15	0.12-0.18	-			
	K2.2.C.UT	Ghisa grigia Alta resistenza	245	4324	125	185	220	15.00-18.00	-	0.08-0.08	0.08-0.08	0.08-0.12	-	-	0.08-0.07	0.08-0.07	0.08-0.1	-
				4334	100	145	175	18.01-22.00	-	0.08-0.1	0.08-0.1	0.08-0.14	-	-	0.08-0.09	0.08-0.09	0.08-0.12	-
				4344	75	115	135	22.01-27.00	-	0.08-0.12	0.08-0.12	0.08-0.16	-	-	0.08-0.1	0.08-0.1	0.08-0.13	-
								27.01-33.00	-	0.1-0.14	0.1-0.14	0.1-0.18	-	-	0.1-0.12	0.1-0.12	0.1-0.15	-
								33.01-40.00	-	0.1-0.16	0.1-0.16	0.1-0.2	-	-	0.1-0.14	0.1-0.14	0.1-0.17	-
								40.01-52.00	-	0.12-0.16	0.12-0.16	0.12-0.2	-	-	0.12-0.14	0.12-0.14	0.12-0.17	-
					52.01-65.00	-	0.12-0.16	0.12-0.16	0.12-0.2	-	-	0.12-0.14	0.12-0.14	0.12-0.17	-			
	K3.1.C.UT	Ghisa nodulare Ferritica	155	4324	125	170	205	15.00-18.00	-	0.08-0.08	0.08-0.08	0.08-0.12	-	-	0.08-0.07	0.08-0.07	0.08-0.1	-
				4334	100	140	165	18.01-22.00	-	0.08-0.1	0.08-0.1	0.08-0.14	-	-	0.08-0.09	0.08-0.09	0.08-0.12	-
				4344	80	110	130	22.01-27.00	-	0.08-0.12	0.08-0.12	0.08-0.16	-	-	0.08-0.1	0.08-0.1	0.08-0.13	-
							27.01-33.00	-	0.1-0.14	0.1-0.14	0.1-0.18	-	-	0.1-0.12	0.1-0.12	0.1-0.15	-	
							33.01-40.00	-	0.1-0.16	0.1-0.16	0.1-0.2	-	-	0.1-0.14	0.1-0.14	0.1-0.17	-	
							40.01-52.00	-	0.12-0.16	0.12-0.16	0.12-0.2	-	-	0.12-0.14	0.12-0.14	0.12-0.17	-	
				52.01-65.00	-	0.12-0.16	0.12-0.16	0.12-0.2	-	-	0.12-0.14	0.12-0.14	0.12-0.17	-				
K3.3.C.UT	Ghisa nodulare Perlitica	265	4324	110	160	190	15.00-18.00	-	0.08-0.08	0.08-0.08	0.08-0.12	-	-	0.08-0.07	0.08-0.07	0.08-0.1	-	
			4334	90	130	160	18.01-22.00	-	0.08-0.1	0.08-0.1	0.08-0.14	-	-	0.08-0.09	0.08-0.09	0.08-0.12	-	
			4344	70	100	115	22.01-27.00	-	0.08-0.12	0.08-0.12	0.08-0.16	-	-	0.08-0.1	0.08-0.1	0.08-0.13	-	
							27.01-33.00	-	0.1-0.14	0.1-0.14	0.1-0.18	-	-	0.1-0.12	0.1-0.12	0.1-0.15	-	
							33.01-40.00	-	0.1-0.16	0.1-0.16	0.1-0.2	-	-	0.1-0.14	0.1-0.14	0.1-0.17	-	
							40.01-52.00	-	0.12-0.16	0.12-0.16	0.12-0.2	-	-	0.12-0.14	0.12-0.14	0.12-0.17	-	
				52.01-65.00	-	0.12-0.16	0.12-0.16	0.12-0.2	-	-	0.12-0.14	0.12-0.14	0.12-0.17	-				
K4.2.C.UT	Ghisa a grafite compatta (CGI) Elevata resistenza alla trazione (Perlite > 90%)	230	4324	130	190	225	15.00-18.00	-	0.08-0.08	0.08-0.08	0.08-0.12	-	-	0.08-0.07	0.08-0.07	0.08-0.1	-	
			4334	110	155	180	18.01-22.00	-	0.08-0.1	0.08-0.1	0.08-0.14	-	-	0.08-0.09	0.08-0.09	0.08-0.12	-	
			4344	85	115	135	22.01-27.00	-	0.08-0.12	0.08-0.12	0.08-0.16	-	-	0.08-0.1	0.08-0.1	0.08-0.13	-	
							27.01-33.00	-	0.1-0.14	0.1-0.14	0.1-0.18	-	-	0.1-0.12	0.1-0.12	0.1-0.15	-	
							33.01-40.00	-	0.1-0.16	0.1-0.16	0.1-0.2	-	-	0.1-0.14	0.1-0.14	0.1-0.17	-	
							40.01-52.00	-	0.12-0.16	0.12-0.16	0.12-0.2	-	-	0.12-0.14	0.12-0.14	0.12-0.17	-	
				52.01-65.00	-	0.12-0.16	0.12-0.16	0.12-0.2	-	-	0.12-0.14	0.12-0.14	0.12-0.17	-				
H	H1.3.Z.HA	Acciai extra duri Temprato	60 (HRC)	4324	30	60	75	15.00-18.00	-	0.06-0.08	0.06-0.08	0.06-0.08	-	-	0.06-0.07	0.06-0.07	0.06-0.07	-
				4334	30	60	75	18.01-22.00	-	0.06-0.09	0.06-0.09	0.06-0.09	-	-	0.06-0.08	0.06-0.08	0.06-0.08	-
				4344	30	60	75	22.01-27.00	-	0.06-0.1	0.06-0.1	0.06-0.1	-	-	0.06-0.08	0.06-0.08	0.06-0.08	-
								27.01-33.00	-	0.08-0.1	0.08-0.1	0.08-0.1	-	-	0.08-0.09	0.08-0.09	0.08-0.09	-
								33.01-40.00	-	0.08-0.12	0.08-0.12	0.08-0.12	-	-	0.08-0.1	0.08-0.1	0.08-0.1	-
								40.01-52.00	-	0.1-0.12	0.1-0.12	0.1-0.12	-	-	0.1-0.1	0.1-0.1	0.1-0.1	-
								52.01-65.00	-	0.1-0.12	0.1-0.12	0.1-0.12	-	-	0.1-0.1	0.1-0.1	0.1-0.1	-

L'avanzamento in entrata dovrebbe equivalere al 75% della velocità di avanzamento consigliata. L'avanzamento in uscita dovrebbe essere di 0.05 mm/giro.

CoroDrill® DS20

6-7xD

Valori in millimetri

ISO	Codice MC	Materiale	HB	Qualità	Velocità di taglio consigliate			Diametro punta	Lunghezza punta 6xD					Lunghezza punta 7xD				
									-S5W	-L5W	-L6W	-M7W	-H5W	-S5W	-L5W	-L6W	-M7W	-H5W
					6-7xD				Valore iniziale raccomandato a metà del campo di avanzamento									
N	N1.2.ZAG	Leghe a base di alluminio Leghe AlSi, Si ≤ 1%	100	H13A 4344	300	330	360	15.00-18.00	0.06-0.1	0.06-0.1	0.06-0.1	-	-	0.06-0.09	0.06-0.09	0.06-0.09	-	-
					300	330	360	18.01-22.00	0.06-0.12	0.06-0.12	0.06-0.12	-	-	0.06-0.1	0.06-0.1	0.06-0.1	-	-
								22.01-27.00	0.06-0.13	0.06-0.13	0.06-0.13	-	-	0.06-0.11	0.06-0.11	0.06-0.11	-	-
								27.01-33.00	0.08-0.14	0.08-0.14	0.08-0.14	-	-	0.08-0.12	0.08-0.12	0.08-0.12	-	-
								33.01-40.00	0.08-0.16	0.08-0.16	0.08-0.16	-	-	0.08-0.14	0.08-0.14	0.08-0.14	-	-
								40.01-52.00	0.1-0.16	0.1-0.16	0.1-0.16	-	-	0.1-0.14	0.1-0.14	0.1-0.14	-	-
								52.01-65.00	0.1-0.16	0.1-0.16	0.1-0.16	-	-	0.1-0.14	0.1-0.14	0.1-0.14	-	-
	N1.3.C.UT	Leghe a base di alluminio Leghe fuse AlSi (1% < Si < 13%)	75	H13A 4344	250	315	360	15.00-18.00	0.06-0.09	0.06-0.09	0.06-0.09	-	-	0.06-0.08	0.06-0.08	0.06-0.08	-	-
					250	315	360	18.01-22.00	0.06-0.1	0.06-0.1	0.06-0.1	-	-	0.06-0.09	0.06-0.09	0.06-0.09	-	-
								22.01-27.00	0.06-0.12	0.06-0.12	0.06-0.12	-	-	0.06-0.1	0.06-0.1	0.06-0.1	-	-
								27.01-33.00	0.08-0.13	0.08-0.13	0.08-0.13	-	-	0.08-0.11	0.08-0.11	0.08-0.11	-	-
								33.01-40.00	0.08-0.14	0.08-0.14	0.08-0.14	-	-	0.08-0.12	0.08-0.12	0.08-0.12	-	-
								40.01-52.00	0.1-0.14	0.1-0.14	0.1-0.14	-	-	0.1-0.12	0.1-0.12	0.1-0.12	-	-
								52.01-65.00	0.1-0.14	0.1-0.14	0.1-0.14	-	-	0.1-0.12	0.1-0.12	0.1-0.12	-	-
	N1.3.C.AG	Leghe a base di alluminio AlSi cast and aged alloys (1% < Si < 13%)	90	H13A 4344	250	285	315	15.00-18.00	0.06-0.09	0.06-0.09	0.06-0.09	-	-	0.06-0.08	0.06-0.08	0.06-0.08	-	-
					250	285	315	18.01-22.00	0.06-0.1	0.06-0.1	0.06-0.1	-	-	0.06-0.09	0.06-0.09	0.06-0.09	-	-
								22.01-27.00	0.06-0.12	0.06-0.12	0.06-0.12	-	-	0.06-0.1	0.06-0.1	0.06-0.1	-	-
								27.01-33.00	0.08-0.13	0.08-0.13	0.08-0.13	-	-	0.08-0.11	0.08-0.11	0.08-0.11	-	-
								33.01-40.00	0.08-0.14	0.08-0.14	0.08-0.14	-	-	0.08-0.12	0.08-0.12	0.08-0.12	-	-
								40.01-52.00	0.1-0.14	0.1-0.14	0.1-0.14	-	-	0.1-0.12	0.1-0.12	0.1-0.12	-	-
								52.01-65.00	0.1-0.14	0.1-0.14	0.1-0.14	-	-	0.1-0.12	0.1-0.12	0.1-0.12	-	-
	N3.3.U.UT	Leghe a base di rame Leghe a base di rame a lavorabilità migliorata	110	H13A 4344	250	315	360	15.00-18.00	0.06-0.1	0.06-0.1	0.06-0.1	-	-	0.06-0.09	0.06-0.09	0.06-0.09	-	-
					250	315	360	18.01-22.00	0.06-0.12	0.06-0.12	0.06-0.12	-	-	0.06-0.1	0.06-0.1	0.06-0.1	-	-
								22.01-27.00	0.06-0.13	0.06-0.13	0.06-0.13	-	-	0.06-0.11	0.06-0.11	0.06-0.11	-	-
							27.01-33.00	0.08-0.14	0.08-0.14	0.08-0.14	-	-	0.08-0.12	0.08-0.12	0.08-0.12	-	-	
							33.01-40.00	0.08-0.16	0.08-0.16	0.08-0.16	-	-	0.08-0.14	0.08-0.14	0.08-0.14	-	-	
							40.01-52.00	0.1-0.16	0.1-0.16	0.1-0.16	-	-	0.1-0.14	0.1-0.14	0.1-0.14	-	-	
							52.01-65.00	0.1-0.16	0.1-0.16	0.1-0.16	-	-	0.1-0.14	0.1-0.14	0.1-0.14	-	-	
N3.2.C.UT	Leghe a base di rame Bronzi e ottoni al piombo (Pb<1%)	90	H13A 4344	180	200	215	15.00-18.00	0.06-0.1	0.06-0.1	0.06-0.1	-	-	0.06-0.09	0.06-0.09	0.06-0.09	-	-	
				180	200	215	18.01-22.00	0.06-0.12	0.06-0.12	0.06-0.12	-	-	0.06-0.1	0.06-0.1	0.06-0.1	-	-	
							22.01-27.00	0.06-0.13	0.06-0.13	0.06-0.13	-	-	0.06-0.11	0.06-0.11	0.06-0.11	-	-	
							27.01-33.00	0.08-0.14	0.08-0.14	0.08-0.14	-	-	0.08-0.12	0.08-0.12	0.08-0.12	-	-	
							33.01-40.00	0.08-0.16	0.08-0.16	0.08-0.16	-	-	0.08-0.14	0.08-0.14	0.08-0.14	-	-	
							40.01-52.00	0.1-0.16	0.1-0.16	0.1-0.16	-	-	0.1-0.14	0.1-0.14	0.1-0.14	-	-	
							52.01-65.00	0.1-0.16	0.1-0.16	0.1-0.16	-	-	0.1-0.14	0.1-0.14	0.1-0.14	-	-	

L'avanzamento in entrata dovrebbe equivalere al 75% della velocità di avanzamento consigliata. L'avanzamento in uscita dovrebbe essere di 0.05 mm/giro.

CoroDrill® DS20

4-5xD

Valori in pollici

ISO	Codice MC	Materiale	HB	Qualità	Velocità di taglio consigliate			Diametro punta	Lunghezza della punta 4xD					Lunghezza della punta 5xD				
									-S5W	-L5W	-L6W	-M7W	-H5W	-S5W	-L5W	-L6W	-M7W	-H5W
									Valore iniziale raccomandato a metà del campo di avanzamento					Valore iniziale raccomandato a metà del campo di avanzamento				
K	K1.1.C.NS	Ghisa malleabile Bassa resistenza	200	4324	460	685	805	0.591-0.709	-	0.003-0.006	0.003-0.006	0.003-0.008	-	-	0.003-0.005	0.003-0.005	0.003-0.007	-
				4334	360	550	655	0.709-0.866	-	0.003-0.007	0.003-0.007	0.003-0.009	-	-	0.003-0.006	0.003-0.006	0.003-0.008	-
				4344	590	540	510	0.866-1.063	-	0.003-0.008	0.003-0.008	0.003-0.01	-	-	0.003-0.007	0.003-0.007	0.003-0.009	-
								1.063-1.299	-	0.004-0.009	0.004-0.009	0.004-0.011	-	-	0.004-0.008	0.004-0.008	0.004-0.01	-
								1.299-1.575	-	0.004-0.011	0.004-0.011	0.004-0.013	-	-	0.004-0.009	0.004-0.009	0.004-0.011	-
								1.575-2.047	-	0.005-0.011	0.005-0.011	0.005-0.013	-	-	0.005-0.009	0.005-0.009	0.005-0.011	-
					2.047-2.559	-	0.005-0.011	0.005-0.011	0.005-0.013	-	-	0.005-0.009	0.005-0.009	0.005-0.011	-			
	K2.1.C.UT	Ghisa grigia Bassa resistenza	180	4324	690	935	1065	0.591-0.709	-	0.003-0.006	0.003-0.006	0.003-0.008	-	-	0.003-0.005	0.003-0.005	0.003-0.007	-
				4334	560	770	885	0.709-0.866	-	0.003-0.007	0.003-0.007	0.003-0.009	-	-	0.003-0.006	0.003-0.006	0.003-0.008	-
				4344	425	585	670	0.866-1.063	-	0.003-0.008	0.003-0.008	0.003-0.01	-	-	0.003-0.007	0.003-0.007	0.003-0.009	-
								1.063-1.299	-	0.004-0.009	0.004-0.009	0.004-0.011	-	-	0.004-0.008	0.004-0.008	0.004-0.01	-
								1.299-1.575	-	0.004-0.011	0.004-0.011	0.004-0.013	-	-	0.004-0.009	0.004-0.009	0.004-0.011	-
							1.575-2.047	-	0.005-0.011	0.005-0.011	0.005-0.013	-	-	0.005-0.009	0.005-0.009	0.005-0.011	-	
				2.047-2.559	-	0.005-0.011	0.005-0.011	0.005-0.013	-	-	0.005-0.009	0.005-0.009	0.005-0.011	-				
K2.2.C.UT	Ghisa grigia Alta resistenza	245	4324	410	665	805	0.591-0.709	-	0.003-0.005	0.003-0.005	0.003-0.007	-	-	0.003-0.004	0.003-0.004	0.003-0.006	-	
			4334	330	530	640	0.709-0.866	-	0.003-0.006	0.003-0.006	0.003-0.008	-	-	0.003-0.005	0.003-0.005	0.003-0.007	-	
			4344	245	405	490	0.866-1.063	-	0.003-0.007	0.003-0.007	0.003-0.009	-	-	0.003-0.006	0.003-0.006	0.003-0.008	-	
							1.063-1.299	-	0.004-0.009	0.004-0.009	0.004-0.011	-	-	0.004-0.007	0.004-0.007	0.004-0.009	-	
							1.299-1.575	-	0.004-0.01	0.004-0.01	0.004-0.012	-	-	0.004-0.008	0.004-0.008	0.004-0.01	-	
							1.575-2.047	-	0.005-0.01	0.005-0.01	0.005-0.012	-	-	0.005-0.008	0.005-0.008	0.005-0.01	-	
				2.047-2.559	-	0.005-0.01	0.005-0.01	0.005-0.012	-	-	0.005-0.008	0.005-0.008	0.005-0.01	-				
K3.1.C.UT	Ghisa nodulare Ferritica	155	4324	410	625	740	0.591-0.709	-	0.003-0.005	0.003-0.005	0.003-0.007	-	-	0.003-0.004	0.003-0.004	0.003-0.006	-	
			4334	330	510	605	0.709-0.866	-	0.003-0.006	0.003-0.006	0.003-0.008	-	-	0.003-0.005	0.003-0.005	0.003-0.007	-	
			4344	260	400	475	0.866-1.063	-	0.003-0.007	0.003-0.007	0.003-0.009	-	-	0.003-0.006	0.003-0.006	0.003-0.008	-	
							1.063-1.299	-	0.004-0.009	0.004-0.009	0.004-0.011	-	-	0.004-0.007	0.004-0.007	0.004-0.009	-	
							1.299-1.575	-	0.004-0.01	0.004-0.01	0.004-0.012	-	-	0.004-0.008	0.004-0.008	0.004-0.01	-	
							1.575-2.047	-	0.005-0.01	0.005-0.01	0.005-0.012	-	-	0.005-0.008	0.005-0.008	0.005-0.01	-	
				2.047-2.559	-	0.005-0.01	0.005-0.01	0.005-0.012	-	-	0.005-0.008	0.005-0.008	0.005-0.01	-				
K3.3.C.UT	Ghisa nodulare Ferritica	265	4324	360	575	690	0.591-0.709	-	0.003-0.005	0.003-0.005	0.003-0.007	-	-	0.003-0.004	0.003-0.004	0.003-0.006	-	
			4334	295	475	575	0.709-0.866	-	0.003-0.006	0.003-0.006	0.003-0.008	-	-	0.003-0.005	0.003-0.005	0.003-0.007	-	
			4344	230	355	425	0.866-1.063	-	0.003-0.007	0.003-0.007	0.003-0.009	-	-	0.003-0.006	0.003-0.006	0.003-0.008	-	
							1.063-1.299	-	0.004-0.009	0.004-0.009	0.004-0.011	-	-	0.004-0.007	0.004-0.007	0.004-0.009	-	
							1.299-1.575	-	0.004-0.01	0.004-0.01	0.004-0.012	-	-	0.004-0.008	0.004-0.008	0.004-0.01	-	
							1.575-2.047	-	0.005-0.01	0.005-0.01	0.005-0.012	-	-	0.005-0.008	0.005-0.008	0.005-0.01	-	
				2.047-2.559	-	0.005-0.01	0.005-0.01	0.005-0.012	-	-	0.005-0.008	0.005-0.008	0.005-0.01	-				
K4.2.C.UT	Ghisa a grafite compatta (CGI) Alta resistenza	230	4324	425	680	820	0.591-0.709	-	0.003-0.005	0.003-0.005	0.003-0.007	-	-	0.003-0.004	0.003-0.004	0.003-0.006	-	
			4334	360	550	655	0.709-0.866	-	0.003-0.006	0.003-0.006	0.003-0.008	-	-	0.003-0.005	0.003-0.005	0.003-0.007	-	
			4344	280	415	490	0.866-1.063	-	0.003-0.007	0.003-0.007	0.003-0.009	-	-	0.003-0.006	0.003-0.006	0.003-0.008	-	
							1.063-1.299	-	0.004-0.009	0.004-0.009	0.004-0.011	-	-	0.004-0.007	0.004-0.007	0.004-0.009	-	
							1.299-1.575	-	0.004-0.01	0.004-0.01	0.004-0.012	-	-	0.004-0.008	0.004-0.008	0.004-0.01	-	
							1.575-2.047	-	0.005-0.01	0.005-0.01	0.005-0.012	-	-	0.005-0.008	0.005-0.008	0.005-0.01	-	
				2.047-2.559	-	0.005-0.01	0.005-0.01	0.005-0.012	-	-	0.005-0.008	0.005-0.008	0.005-0.01	-				
H	H1.3.Z.HA	Acciaio molto duro Temprato	60	100	215	280	0.591-0.709	-	0.002-0.005	0.002-0.005	0.002-0.005	-	-	0.002-0.004	0.002-0.004	0.002-0.004	-	
			(HRC) 4334	100	215	280	0.709-0.866	-	0.002-0.006	0.002-0.006	0.002-0.006	-	-	0.002-0.005	0.002-0.005	0.002-0.005	-	
			4344	100	215	280	0.866-1.063	-	0.002-0.006	0.002-0.006	0.002-0.006	-	-	0.002-0.005	0.002-0.005	0.002-0.005	-	
							1.063-1.299	-	0.003-0.006	0.003-0.006	0.003-0.006	-	-	0.003-0.005	0.003-0.005	0.003-0.005	-	
							1.299-1.575	-	0.003-0.007	0.003-0.007	0.003-0.007	-	-	0.003-0.006	0.003-0.006	0.003-0.006	-	
							1.575-2.047	-	0.004-0.007	0.004-0.007	0.004-0.007	-	-	0.004-0.006	0.004-0.006	0.004-0.006	-	
				2.047-2.559	-	0.004-0.007	0.004-0.007	0.004-0.007	-	-	0.004-0.006	0.004-0.006	0.004-0.006	-				

CoroDrill® DS20

4-5xD

Valori in pollici

ISO	Codice MC	Materiale	HB	Qualità	Velocità di taglio consigliate			Diametro punta	Lunghezza della punta 4xD					Lunghezza della punta 5xD					
									-S5W	-L5W	-L6W	-M7W	-H5W	-S5W	-L5W	-L6W	-M7W	-H5W	
					4-5xD				Valore iniziale raccomandato a metà del campo di avanzamento										
N	N1.2.ZAG	Leghe a base di alluminio Leghe AISi, Si ≤ 1%	100	H13A 4344	985	1195	1310	0.591-0.709	0.002-0.006	0.002-0.006	0.002-0.006	-	-	0.002-0.005	0.002-0.005	0.002-0.005	-	-	
					985	1195	1310	0.709-0.866	0.002-0.007	0.002-0.007	0.002-0.007	-	-	0.002-0.006	0.002-0.006	0.002-0.006	-	-	
								0.866-1.063	0.002-0.008	0.002-0.008	0.002-0.008	-	-	0.002-0.007	0.002-0.007	0.002-0.007	-	-	
								1.063-1.299	0.003-0.009	0.003-0.009	0.003-0.009	-	-	0.003-0.007	0.003-0.007	0.003-0.007	-	-	
								1.299-1.575	0.003-0.01	0.003-0.01	0.003-0.01	-	-	0.003-0.008	0.003-0.008	0.003-0.008	-	-	
								1.575-2.047	0.004-0.01	0.004-0.01	0.004-0.01	-	-	0.004-0.008	0.004-0.008	0.004-0.008	-	-	
								2.047-2.559	0.004-0.01	0.004-0.01	0.004-0.01	-	-	0.004-0.008	0.004-0.008	0.004-0.008	-	-	
		N1.3.C.UT	Leghe a base di alluminio Leghe AISi, Si ≤ 1%	75	H13A 4344	820	1140	1310	0.591-0.709	0.002-0.006	0.002-0.006	0.002-0.006	-	-	0.002-0.005	0.002-0.005	0.002-0.005	-	-
	820					1140	1310	0.709-0.866	0.002-0.006	0.002-0.006	0.002-0.006	-	-	0.002-0.005	0.002-0.005	0.002-0.005	-	-	
								0.866-1.063	0.002-0.007	0.002-0.007	0.002-0.007	-	-	0.002-0.006	0.002-0.006	0.002-0.006	-	-	
								1.063-1.299	0.003-0.008	0.003-0.008	0.003-0.008	-	-	0.003-0.007	0.003-0.007	0.003-0.007	-	-	
								1.299-1.575	0.003-0.009	0.003-0.009	0.003-0.009	-	-	0.003-0.007	0.003-0.007	0.003-0.007	-	-	
								1.575-2.047	0.004-0.009	0.004-0.009	0.004-0.009	-	-	0.004-0.007	0.004-0.007	0.004-0.007	-	-	
								2.047-2.559	0.004-0.009	0.004-0.009	0.004-0.009	-	-	0.004-0.007	0.004-0.007	0.004-0.007	-	-	
		N1.3.C.AG	Leghe a base di alluminio AISI cast and aged alloys (1% < Si < 13%)	90	H13A 4344	820	1035	1150	0.591-0.709	0.002-0.006	0.002-0.006	0.002-0.006	-	-	0.002-0.005	0.002-0.005	0.002-0.005	-	-
	820					1035	1150	0.709-0.866	0.002-0.006	0.002-0.006	0.002-0.006	-	-	0.002-0.005	0.002-0.005	0.002-0.005	-	-	
								0.866-1.063	0.002-0.007	0.002-0.007	0.002-0.007	-	-	0.002-0.006	0.002-0.006	0.002-0.006	-	-	
								1.063-1.299	0.003-0.008	0.003-0.008	0.003-0.008	-	-	0.003-0.007	0.003-0.007	0.003-0.007	-	-	
								1.299-1.575	0.003-0.009	0.003-0.009	0.003-0.009	-	-	0.003-0.007	0.003-0.007	0.003-0.007	-	-	
								1.575-2.047	0.004-0.009	0.004-0.009	0.004-0.009	-	-	0.004-0.007	0.004-0.007	0.004-0.007	-	-	
								2.047-2.559	0.004-0.009	0.004-0.009	0.004-0.009	-	-	0.004-0.007	0.004-0.007	0.004-0.007	-	-	
	N3.3.U.UT	Leghe a base di rame Leghe a base di rame a lavorabilità migliorata	110	H13A 4344	820	1140	1310	0.591-0.709	0.002-0.006	0.002-0.006	0.002-0.006	-	-	0.002-0.005	0.002-0.005	0.002-0.005	-	-	
820					1140	1310	0.709-0.866	0.002-0.007	0.002-0.007	0.002-0.007	-	-	0.002-0.006	0.002-0.006	0.002-0.006	-	-		
							0.866-1.063	0.002-0.008	0.002-0.008	0.002-0.008	-	-	0.002-0.007	0.002-0.007	0.002-0.007	-	-		
							1.063-1.299	0.003-0.009	0.003-0.009	0.003-0.009	-	-	0.003-0.007	0.003-0.007	0.003-0.007	-	-		
							1.299-1.575	0.003-0.01	0.003-0.01	0.003-0.01	-	-	0.003-0.008	0.003-0.008	0.003-0.008	-	-		
							1.575-2.047	0.004-0.01	0.004-0.01	0.004-0.01	-	-	0.004-0.008	0.004-0.008	0.004-0.008	-	-		
							2.047-2.559	0.004-0.01	0.004-0.01	0.004-0.01	-	-	0.004-0.008	0.004-0.008	0.004-0.008	-	-		
	N3.2.C.UT	Leghe a base di rame Bronzi e ottoni al piombo (Pb ≤ 1%)	90	H13A 4344	590	715	785	0.591-0.709	0.002-0.006	0.002-0.006	0.002-0.006	-	-	0.002-0.005	0.002-0.005	0.002-0.005	-	-	
590					715	785	0.709-0.866	0.002-0.007	0.002-0.007	0.002-0.007	-	-	0.002-0.006	0.002-0.006	0.002-0.006	-	-		
							0.866-1.063	0.002-0.008	0.002-0.008	0.002-0.008	-	-	0.002-0.007	0.002-0.007	0.002-0.007	-	-		
							1.063-1.299	0.003-0.009	0.003-0.009	0.003-0.009	-	-	0.003-0.007	0.003-0.007	0.003-0.007	-	-		
							1.299-1.575	0.003-0.01	0.003-0.01	0.003-0.01	-	-	0.003-0.008	0.003-0.008	0.003-0.008	-	-		
							1.575-2.047	0.004-0.01	0.004-0.01	0.004-0.01	-	-	0.004-0.008	0.004-0.008	0.004-0.008	-	-		
							2.047-2.559	0.004-0.01	0.004-0.01	0.004-0.01	-	-	0.004-0.008	0.004-0.008	0.004-0.008	-	-		

CoroDrill® DS20

6-7xD

Valori in pollici

ISO	Codice MC	Materiale	HB	Qualità	Velocità di taglio consigliate			Diametro punta	Lunghezza punta 6xD					Lunghezza punta 7xD				
									-S5W	-L5W	-L6W	-M7W	-H5W	-S5W	-L5W	-L6W	-M7W	-H5W
6-7xD									Valore iniziale raccomandato a metà del campo di avanzamento					Valore iniziale raccomandato a metà del campo di avanzamento				
K	K1.1.C.NS	Ghisa malleabile Bassa resistenza	200	4324	460	615	725	0.591-0.709	-	0.003-0.004	0.003-0.004	0.003-0.005	-	-	0.003-0.003	0.003-0.003	0.003-0.004	-
				4334	360	495	590	0.709-0.866	-	0.003-0.005	0.003-0.005	0.003-0.006	-	-	0.003-0.004	0.003-0.004	0.003-0.005	-
				4344	590	485	460	0.866-1.063	-	0.003-0.005	0.003-0.005	0.003-0.007	-	-	0.003-0.005	0.003-0.005	0.003-0.006	-
								1.063-1.299	-	0.004-0.006	0.004-0.006	0.004-0.007	-	-	0.004-0.005	0.004-0.005	0.004-0.006	-
								1.299-1.575	-	0.004-0.007	0.004-0.007	0.004-0.008	-	-	0.004-0.006	0.004-0.006	0.004-0.007	-
								1.575-2.047	-	0.005-0.007	0.005-0.007	0.005-0.008	-	-	0.005-0.006	0.005-0.006	0.005-0.007	-
								2.047-2.559	-	0.005-0.007	0.005-0.007	0.005-0.008	-	-	0.005-0.006	0.005-0.006	0.005-0.007	-
	K2.1.C.UT	Ghisa grigia Bassa resistenza	180	4324	690	840	960	0.591-0.709	-	0.003-0.004	0.003-0.004	0.003-0.005	-	-	0.003-0.003	0.003-0.003	0.003-0.004	-
				4334	560	695	795	0.709-0.866	-	0.003-0.005	0.003-0.005	0.003-0.006	-	-	0.003-0.004	0.003-0.004	0.003-0.005	-
				4344	425	525	605	0.866-1.063	-	0.003-0.005	0.003-0.005	0.003-0.007	-	-	0.003-0.005	0.003-0.005	0.003-0.006	-
								1.063-1.299	-	0.004-0.006	0.004-0.006	0.004-0.007	-	-	0.004-0.005	0.004-0.005	0.004-0.006	-
								1.299-1.575	-	0.004-0.007	0.004-0.007	0.004-0.008	-	-	0.004-0.006	0.004-0.006	0.004-0.007	-
								1.575-2.047	-	0.005-0.007	0.005-0.007	0.005-0.008	-	-	0.005-0.006	0.005-0.006	0.005-0.007	-
								2.047-2.559	-	0.005-0.007	0.005-0.007	0.005-0.008	-	-	0.005-0.006	0.005-0.006	0.005-0.007	-
	K2.2.C.UT	Ghisa grigia Alta resistenza	245	4324	410	600	725	0.591-0.709	-	0.003-0.003	0.003-0.003	0.003-0.005	-	-	0.003-0.003	0.003-0.003	0.003-0.004	-
				4334	330	475	575	0.709-0.866	-	0.003-0.004	0.003-0.004	0.003-0.005	-	-	0.003-0.003	0.003-0.003	0.003-0.005	-
				4344	245	365	440	0.866-1.063	-	0.003-0.005	0.003-0.005	0.003-0.006	-	-	0.003-0.004	0.003-0.004	0.003-0.005	-
								1.063-1.299	-	0.004-0.006	0.004-0.006	0.004-0.007	-	-	0.004-0.005	0.004-0.005	0.004-0.006	-
								1.299-1.575	-	0.004-0.006	0.004-0.006	0.004-0.008	-	-	0.004-0.005	0.004-0.005	0.004-0.006	-
								1.575-2.047	-	0.005-0.006	0.005-0.006	0.005-0.008	-	-	0.005-0.005	0.005-0.005	0.005-0.006	-
								2.047-2.559	-	0.005-0.006	0.005-0.006	0.005-0.008	-	-	0.005-0.005	0.005-0.005	0.005-0.006	-
	K3.1.C.UT	Ghisa nodulare Ferritica	155	4324	410	565	665	0.591-0.709	-	0.003-0.003	0.003-0.003	0.003-0.005	-	-	0.003-0.003	0.003-0.003	0.003-0.004	-
				4334	330	460	545	0.709-0.866	-	0.003-0.004	0.003-0.004	0.003-0.005	-	-	0.003-0.003	0.003-0.003	0.003-0.005	-
				4344	260	360	430	0.866-1.063	-	0.003-0.005	0.003-0.005	0.003-0.006	-	-	0.003-0.004	0.003-0.004	0.003-0.005	-
							1.063-1.299	-	0.004-0.006	0.004-0.006	0.004-0.007	-	-	0.004-0.005	0.004-0.005	0.004-0.006	-	
							1.299-1.575	-	0.004-0.006	0.004-0.006	0.004-0.008	-	-	0.004-0.005	0.004-0.005	0.004-0.006	-	
							1.575-2.047	-	0.005-0.006	0.005-0.006	0.005-0.008	-	-	0.005-0.005	0.005-0.005	0.005-0.006	-	
							2.047-2.559	-	0.005-0.006	0.005-0.006	0.005-0.008	-	-	0.005-0.005	0.005-0.005	0.005-0.006	-	
K3.3.C.UT	Ghisa nodulare Ferritica	265	4324	360	520	620	0.591-0.709	-	0.003-0.003	0.003-0.003	0.003-0.005	-	-	0.003-0.003	0.003-0.003	0.003-0.004	-	
			4334	295	430	520	0.709-0.866	-	0.003-0.004	0.003-0.004	0.003-0.005	-	-	0.003-0.003	0.003-0.003	0.003-0.005	-	
			4344	230	320	385	0.866-1.063	-	0.003-0.005	0.003-0.005	0.003-0.006	-	-	0.003-0.004	0.003-0.004	0.003-0.005	-	
							1.063-1.299	-	0.004-0.006	0.004-0.006	0.004-0.007	-	-	0.004-0.005	0.004-0.005	0.004-0.006	-	
							1.299-1.575	-	0.004-0.006	0.004-0.006	0.004-0.008	-	-	0.004-0.005	0.004-0.005	0.004-0.006	-	
							1.575-2.047	-	0.005-0.006	0.005-0.006	0.005-0.008	-	-	0.005-0.005	0.005-0.005	0.005-0.006	-	
							2.047-2.559	-	0.005-0.006	0.005-0.006	0.005-0.008	-	-	0.005-0.005	0.005-0.005	0.005-0.006	-	
K4.2.C.UT	Ghisa a grafite compatta (CGI) Alta resistenza	230	4324	425	610	740	0.591-0.709	-	0.003-0.003	0.003-0.003	0.003-0.005	-	-	0.003-0.003	0.003-0.003	0.003-0.004	-	
			4334	360	495	590	0.709-0.866	-	0.003-0.004	0.003-0.004	0.003-0.005	-	-	0.003-0.003	0.003-0.003	0.003-0.005	-	
			4344	280	375	440	0.866-1.063	-	0.003-0.005	0.003-0.005	0.003-0.006	-	-	0.003-0.004	0.003-0.004	0.003-0.005	-	
							1.063-1.299	-	0.004-0.006	0.004-0.006	0.004-0.007	-	-	0.004-0.005	0.004-0.005	0.004-0.006	-	
							1.299-1.575	-	0.004-0.006	0.004-0.006	0.004-0.008	-	-	0.004-0.005	0.004-0.005	0.004-0.006	-	
							1.575-2.047	-	0.005-0.006	0.005-0.006	0.005-0.008	-	-	0.005-0.005	0.005-0.005	0.005-0.006	-	
							2.047-2.559	-	0.005-0.006	0.005-0.006	0.005-0.008	-	-	0.005-0.005	0.005-0.005	0.005-0.006	-	
H	H1.3.Z.HA	Acciaio molto duro Temprato	60 (HRC)	4324	100	195	250	0.591-0.709	-	0.002-0.003	0.002-0.003	0.002-0.003	-	-	0.002-0.003	0.002-0.003	0.002-0.003	-
				4334	100	195	250	0.709-0.866	-	0.002-0.004	0.002-0.004	0.002-0.004	-	-	0.002-0.003	0.002-0.003	0.002-0.003	-
				4344	100	195	250	0.866-1.063	-	0.002-0.004	0.002-0.004	0.002-0.004	-	-	0.002-0.003	0.002-0.003	0.002-0.003	-
								1.063-1.299	-	0.003-0.004	0.003-0.004	0.003-0.004	-	-	0.003-0.003	0.003-0.003	0.003-0.003	-
								1.299-1.575	-	0.003-0.005	0.003-0.005	0.003-0.005	-	-	0.003-0.004	0.003-0.004	0.003-0.004	-
								1.575-2.047	-	0.004-0.005	0.004-0.005	0.004-0.005	-	-	0.004-0.004	0.004-0.004	0.004-0.004	-
								2.047-2.559	-	0.004-0.005	0.004-0.005	0.004-0.005	-	-	0.004-0.004	0.004-0.004	0.004-0.004	-

L'avanzamento in entrata dovrebbe equivalere al 75% della velocità di avanzamento consigliata. L'avanzamento in uscita dovrebbe essere di 0.002 pollici/giro.

CoroDrill® DS20

6-7xD

Valori in pollici

ISO	Codice MC	Materiale	HB	Qualità	Velocità di taglio consigliate			Diametro punta	Lunghezza punta 6xD					Lunghezza punta 7xD					
									-SSW	-LSW	-L6W	-M7W	-H5W	-SSW	-LSW	-L6W	-M7W	-H5W	
								Valore iniziale raccomandato a metà del campo di avanzamento											
								6-7xD											
N	N1.2.ZAG	Leghe a base di alluminio Leghe AISi, Si ≤ 1%	100	H13A 4344	985	1075	1180	0.591-0.709	0.002-0.004	0.002-0.004	0.002-0.004	-	-	0.002-0.003	0.002-0.003	0.002-0.003	-	-	
					985	1075	1180	0.709-0.866	0.002-0.005	0.002-0.005	0.002-0.005	-	-	0.002-0.004	0.002-0.004	0.002-0.004	-	-	
						0.866-1.063	0.002-0.005	0.002-0.005	0.002-0.005	-	-	0.002-0.004	0.002-0.004	0.002-0.004	-	-			
						1.063-1.299	0.003-0.006	0.003-0.006	0.003-0.006	-	-	0.003-0.005	0.003-0.005	0.003-0.005	-	-			
						1.299-1.575	0.003-0.006	0.003-0.006	0.003-0.006	-	-	0.003-0.005	0.003-0.005	0.003-0.005	-	-			
						1.575-2.047	0.004-0.006	0.004-0.006	0.004-0.006	-	-	0.004-0.005	0.004-0.005	0.004-0.005	-	-			
		2.047-2.559	0.004-0.006	0.004-0.006	0.004-0.006	-	-	0.004-0.005	0.004-0.005	0.004-0.005	-	-							
		N1.3.C.UT	Leghe a base di alluminio Leghe AISi, Si ≤ 1%	75	H13A 4344	820	1025	1180	0.591-0.709	0.002-0.004	0.002-0.004	0.002-0.004	-	-	0.002-0.003	0.002-0.003	0.002-0.003	-	-
	820					1025	1180	0.709-0.866	0.002-0.004	0.002-0.004	0.002-0.004	-	-	0.002-0.003	0.002-0.003	0.002-0.003	-	-	
						0.866-1.063	0.002-0.005	0.002-0.005	0.002-0.005	-	-	0.002-0.004	0.002-0.004	0.002-0.004	-	-			
						1.063-1.299	0.003-0.005	0.003-0.005	0.003-0.005	-	-	0.003-0.004	0.003-0.004	0.003-0.004	-	-			
						1.299-1.575	0.003-0.006	0.003-0.006	0.003-0.006	-	-	0.003-0.005	0.003-0.005	0.003-0.005	-	-			
						1.575-2.047	0.004-0.006	0.004-0.006	0.004-0.006	-	-	0.004-0.005	0.004-0.005	0.004-0.005	-	-			
		2.047-2.559	0.004-0.006	0.004-0.006	0.004-0.006	-	-	0.004-0.005	0.004-0.005	0.004-0.005	-	-							
		N1.3.C.AG	Leghe a base di alluminio AISI cast and aged alloys (1% < Si < 13%)	90	H13A 4344	820	930	1035	0.591-0.709	0.002-0.004	0.002-0.004	0.002-0.004	-	-	0.002-0.003	0.002-0.003	0.002-0.003	-	-
	820					930	1035	0.709-0.866	0.002-0.004	0.002-0.004	0.002-0.004	-	-	0.002-0.003	0.002-0.003	0.002-0.003	-	-	
						0.866-1.063	0.002-0.005	0.002-0.005	0.002-0.005	-	-	0.002-0.004	0.002-0.004	0.002-0.004	-	-			
						1.063-1.299	0.003-0.005	0.003-0.005	0.003-0.005	-	-	0.003-0.004	0.003-0.004	0.003-0.004	-	-			
						1.299-1.575	0.003-0.006	0.003-0.006	0.003-0.006	-	-	0.003-0.005	0.003-0.005	0.003-0.005	-	-			
						1.575-2.047	0.004-0.006	0.004-0.006	0.004-0.006	-	-	0.004-0.005	0.004-0.005	0.004-0.005	-	-			
		2.047-2.559	0.004-0.006	0.004-0.006	0.004-0.006	-	-	0.004-0.005	0.004-0.005	0.004-0.005	-	-							
		N3.3.U.UT	Leghe a base di rame Leghe a base di rame a lavorabilità migliorata	110	H13A 4344	820	1025	1180	0.591-0.709	0.002-0.004	0.002-0.004	0.002-0.004	-	-	0.002-0.003	0.002-0.003	0.002-0.003	-	-
	820					1025	1180	0.709-0.866	0.002-0.005	0.002-0.005	0.002-0.005	-	-	0.002-0.004	0.002-0.004	0.002-0.004	-	-	
						0.866-1.063	0.002-0.005	0.002-0.005	0.002-0.005	-	-	0.002-0.004	0.002-0.004	0.002-0.004	-	-			
	1.063-1.299					0.003-0.006	0.003-0.006	0.003-0.006	-	-	0.003-0.005	0.003-0.005	0.003-0.005	-	-				
	1.299-1.575					0.003-0.006	0.003-0.006	0.003-0.006	-	-	0.003-0.005	0.003-0.005	0.003-0.005	-	-				
	1.575-2.047					0.004-0.006	0.004-0.006	0.004-0.006	-	-	0.004-0.005	0.004-0.005	0.004-0.005	-	-				
	2.047-2.559	0.004-0.006	0.004-0.006	0.004-0.006	-	-	0.004-0.005	0.004-0.005	0.004-0.005	-	-								
	N3.2.C.UT	Leghe a base di rame Bronze e ottoni al piombo (Pb ≤ 1%)	90	H13A 4344	590	645	705	0.591-0.709	0.002-0.004	0.002-0.004	0.002-0.004	-	-	0.002-0.003	0.002-0.003	0.002-0.003	-	-	
590					645	705	0.709-0.866	0.002-0.005	0.002-0.005	0.002-0.005	-	-	0.002-0.004	0.002-0.004	0.002-0.004	-	-		
					0.866-1.063	0.002-0.005	0.002-0.005	0.002-0.005	-	-	0.002-0.004	0.002-0.004	0.002-0.004	-	-				
					1.063-1.299	0.003-0.006	0.003-0.006	0.003-0.006	-	-	0.003-0.005	0.003-0.005	0.003-0.005	-	-				
					1.299-1.575	0.003-0.006	0.003-0.006	0.003-0.006	-	-	0.003-0.005	0.003-0.005	0.003-0.005	-	-				
					1.575-2.047	0.004-0.006	0.004-0.006	0.004-0.006	-	-	0.004-0.005	0.004-0.005	0.004-0.005	-	-				
	2.047-2.559	0.004-0.006	0.004-0.006	0.004-0.006	-	-	0.004-0.005	0.004-0.005	0.004-0.005	-	-								

L'avanzamento in entrata dovrebbe equivalere al 75% della velocità di avanzamento consigliata. L'avanzamento in uscita dovrebbe essere di 0.002 pollici/giro.

Selezione dei dati di taglio

Formazione ed evacuazione truciolo sono problemi critici nella foratura e dipendono dal materiale del pezzo, dalla scelta della punta/geometria di inserto, dalla pressione e dal volume del refrigerante e dai dati di taglio. L'intasamento da truciolo può provocare il movimento radiale della punta e incidere, di conseguenza, su qualità del foro, durata e affidabilità della punta e rischio di rottura della punta o dell'inserto.

La formazione dei trucioli è accettabile quando i trucioli possono essere evacuati dalla punta senza ostacoli. Il modo migliore per individuarlo è ascoltare il tipo di rumore. Un suono costante significa che l'evacuazione truciolo è buona, mentre un rumore interrotto denota intasamento da truciolo. Controllare il monitor della forza di avanzamento o della potenza. In presenza di irregolarità, la ragione può essere l'intasamento da truciolo. Osservare i trucioli: se sono lunghi e piegati anziché arrotolati, si è verificato un intasamento. Osservare il foro: in presenza di intasamento da truciolo, la superficie sarà irregolare

Effetti della velocità di taglio – v_c

Velocità di taglio troppo elevata:

Rapida usura sul fianco
Deformazione plastica
Scarsa qualità e scorretta tolleranza del foro

Velocità di taglio troppo ridotta:

Tagliante di riporto
Inadeguata evacuazione truciolo
Tempi di taglio più lunghi

Effetti dell'avanzamento – f_n

Alta velocità di avanzamento:

Più difficile controllo truciolo
Tempo di taglio inferiore
Minore usura dell'utensile ma maggior rischio di rottura della punta
Ridotta qualità del foro

Velocità di avanzamento bassa:

Preferibile per i materiali a truciolo lungo
Maggiore qualità
Usura accelerata degli utensili
Tempi di taglio più lunghi

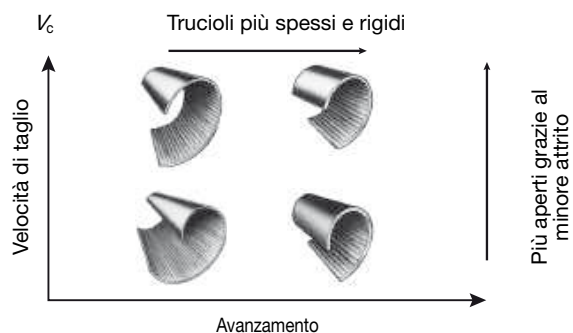

Come ottenere una buona qualità del foro

Evacuazione del truciolo

Verificare che l'evacuazione truciolo sia soddisfacente. L'intasamento da truciolo influisce su qualità del foro e affidabilità/durata utensile. La geometria di punta/inserto e i dati di taglio sono cruciali.

Stabilità, setup dell'utensile

Utilizzare la punta più corta possibile. Utilizzare un portautensili rigido e preciso, con runout minimo. Verificare che il mandrino della macchina sia in buone condizioni e correttamente allineato. Verificare che il componente sia saldamente fissato e stabile. Stabilire le velocità di avanzamento corrette per le superfici irregolari o angolari e per i fori incrociati.

Durata tagliente

Controllare l'usura dell'inserto e stabilire un programma predeterminato di durata utensile. Il modo più efficace di supervisionare la foratura consiste nell'utilizzare un sensore per il monitoraggio della forza di avanzamento.

Manutenzione

Cambiare regolarmente le vite di bloccaggio dell'inserto. Pulire la sede della cuspide prima di cambiare l'inserto e utilizzare una chiave torsionometrica. Non superare l'usura massima consentita prima di riaffilare le punte in metallo duro integrale.

Foratura profonda con CoroDrill® DS20

Se nella realizzazione di fori 6-7xD con CoroDrill DS20 occorre la migliore qualità del foro possibile, è importante utilizzare una velocità di avanzamento ridotta in entrata (primi 1-2 mm) (.039-.787 poll.) e in uscita (ultimi 5 mm) (.197 poll.).

Barenatura

Sgrossatura

CoroBore® 111, inserti per barenatura di sgrossatura

D2

Per informazioni sulla gamma completa, visitare il sito www.sandvik.coromant.com/it

A

BARENATURA

Sgrossatura

CoroBore® 111, inserti per barenatura di sgrossatura

Inserto di tipo S (quadrato)

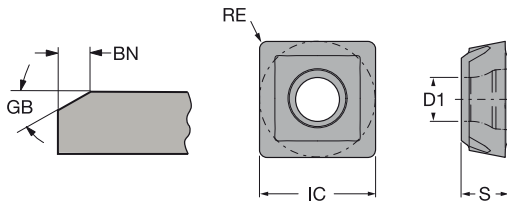
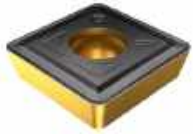

B

C

										P
		S	RE	BSR	GB	BN	CODICE ISO		4425	
Sgrossatura	BR	06	2.60	0.60	5.0	5°	0.10	SPMT0606-BR	★	
			.102	.024	.197	5°	.004			
		08	3.00	0.80	5.0	5°	0.10	SPMT0808-BR	★	
			.118	.031	.197	5°	.004			
		12	4.00	1.20	5.0	5°	0.15	SPMT1212-BR	★	
			.157	.047	.197	5°	.006			
		18	5.50	1.20	5.0	5°	0.15	SPMT1812-BR	★	
			.217	.047	.197	5°	.006			

D

E

F



F2

Adattatori per utensili rotanti

Interfaccia lato macchina Coromant Capto®

Coromant Capto® per adattatore MDI

E2

Interfaccia lato macchina HSK

HSK per adattatore MDI

E3

Per informazioni sulla gamma completa, visitare il sito www.sandvik.coromant.com/it

A

Coromant Capto® per adattatore MDI

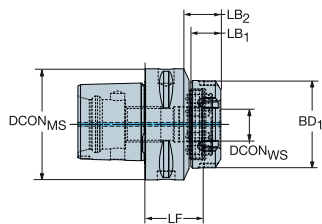

B

Dimensioni in mm e pollici

CZC _{MS}	CZC _{WS}	CNSC	CXSC	Codice di ordinazione	DCON _{MS}	DCON _{WS}	LF	LB ₁	LB ₂	BD ₁	BAR PSI	NM	KG	RPMX
C8	MDI-25	3	1	C8-DM25-N-042	80.0	25.0	42.0	17.0	52.0	62.7	80	170.0	2.08	14000
					3.150	.984	1.654	.669	2.047	2.469	1160			

Per le parti di ricambio, visitate il sito www.sandvik.coromant.com/it

C

D

E

F



F2



F5

HSK per adattatore MDI

Interfaccia lato macchina HSK A/C/T



DSGN

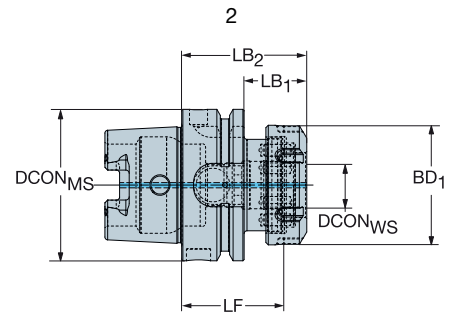
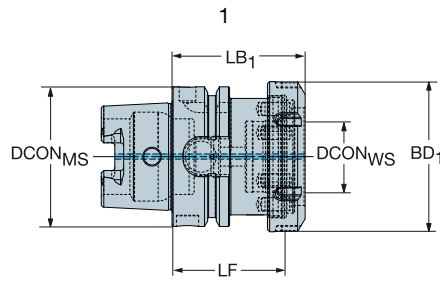

Foro in mm

					Dimensioni in mm e pollici											
CZC _{MS}	CZC _{WS}	CNSC	CXSC	DSGN	Codice di ordinazione	DCON _{MS}	DCON _{WS}	LF	LB ₁	LB ₂	BD ₁	BD ₂	BAR PSI	NM	KG	RPMX
63.0	MDI-40	1	1	1	HT06-DM40-N-061	63.0	40.0	61.0	73.0	79.7	80	230.0	1.51	20500		
						<i>2.480</i>	<i>1.575</i>	<i>2.402</i>	<i>2.874</i>	<i>3.138</i>	<i>1160</i>					
100.0	MDI-25	1	1	2	HT10-DM25-N-048	100.0	25.0	48.0	29.0	58.0	62.7	100.0	80	170.0	2.37	12500
						<i>3.937</i>	<i>.984</i>	<i>1.890</i>	<i>1.142</i>	<i>2.283</i>	<i>2.469</i>	<i>3.937</i>	<i>1160</i>			
	MDI-32	1	1	2	HT10-DM32-N-048	100.0	32.0	48.0	29.0	58.0	67.7	100.0	80	200.0	2.40	12500
						<i>3.937</i>	<i>1.260</i>	<i>1.890</i>	<i>1.142</i>	<i>2.283</i>	<i>2.665</i>	<i>3.937</i>	<i>1160</i>			
	MDI-40	1	1	2	HT10-DM40-N-048	100.0	40.0	48.0	31.0	60.0	79.7	100.0	80	230.0	2.60	12500
						<i>3.937</i>	<i>1.575</i>	<i>1.890</i>	<i>1.220</i>	<i>2.362</i>	<i>3.138</i>	<i>3.937</i>	<i>1160</i>			
	MDI-50	1	1	2	HT10-DM50-N-055	100.0	50.0	55.0	40.0	69.0	94.7	100.0	80	250.0	3.15	12500
						<i>3.937</i>	<i>1.969</i>	<i>2.165</i>	<i>1.575</i>	<i>2.717</i>	<i>3.728</i>	<i>3.937</i>	<i>1160</i>			

Per le parti di ricambio, visitate il sito www.sandvik.coromant.com/it



Informazioni generali

ISO 13399	F2
Informazioni sull'adduzione di refrigerante	F5
Ricondizionamento	F6
Informazioni per la sicurezza	F7
Concetto di Riciclo Coromant (CRC)	F8

ISO 13399 è uno standard internazionale che semplifica lo scambio dei dati per gli utensili da taglio. Esiste una leggera differenza nei parametri e nelle descrizioni di ogni utensile.

Per la prima volta, c'è un modo standardizzato per descrivere i dati dei prodotti per quanto riguarda gli utensili da taglio disponibili. Quando tutti gli utensili nell'industria manifatturiera condividono gli stessi parametri e definizioni, la comunicazione delle relative informazioni tra i vari sistemi software diventa molto semplice.

B

Che cosa significa per voi?

Fondamentalmente, ciò significa che i vostri sistemi possono parlare con i nostri, perché tutti parlano la stessa lingua. Scaricate i dati dei prodotti dal nostro sito web e inseriteli direttamente nel vostro software CAD/CAM per assemblare gli utensili che si utilizzano in produzione. Non c'è bisogno di cercare informazioni nei cataloghi e interpretare i dati da un sistema all'altro. Immaginate quanto tempo questo sistema vi farà risparmiare!



Acronimo	Significato
ADJLN	Limite di regolazione minimo
ADJLX	Massimo limite di regolazione
ADJRG	Gamma di regolazione
ALP	Angolo di spoglia inferiore assiale
AN	Angolo di spoglia inferiore principale
ANN	Angolo di spoglia inferiore secondario
APMX	Profondità di taglio massima
APMX_EFW	Profondità di taglio massima - avanzamento finale
APMX_FFW	Profondità di taglio massima - avanzamento laterale
AZ	Profondità di tuffo massima
B	Larghezza dello stelo
BAWS	Angolo del corpo lato pezzo
BAMS	Angolo del corpo lato macchina
BBD	Bilanciato in fase di progettazione
BBR	Bilanciato mediante prova rotazionale
BCH	Lunghezza dello smusso angolare
BD	Diametro del corpo
BHTA	Angolo semiconico del corpo
BN	Larghezza del petto
BS	Lunghezza del tagliente raschiante
BSG	Gruppo standard di base
BSR	Raggio del tagliente raschiante
CBMD	Costruttore rompitruccoli
CDX	Profondità di taglio massima
CEMR	Raggio principale del tagliente
CF	Smusso di invito
CHBA	Angolo dello smusso del corpo
CHBL	Lunghezza dello smusso del corpo
CHW	Larghezza dello smusso angolare
CICT	Numero di articoli da taglio
CICT ^{BALL}	Numero di articoli da taglio - inserto a testa sferica
CICT ^E	Numero di articoli da taglio - posizione finale
CICT ^P	Numero di articoli da taglio - posizione periferica
CICT ^S	Numero di articoli da taglio - posizione laterale
CICT ^{SP}	Numero di articoli da taglio - Inserto di "guardia"
CICT ^T	Numero di articoli da taglio - totale
CND	Diametro ingresso refrigerante
CNSC	Codice tipo con ingresso refrigerante
CNT	Misura della filettatura all'ingresso refrigerante
COATING	Rivestimento
CP	Pressione massima refrigerante
CRKS	Misura della filettatura della bussola di arresto del collegamento
CRNT	Misura della filettatura dell'ingresso radiale del refrigerante
CTPT	Tipo di operazione
CUTDIA	Diametro massimo di troncatura del pezzo
CW	Larghezza di taglio
CWN	Larghezza di taglio minima
CWTOLL	Tolleranza inferiore larghezza di taglio
CWTOLU	Tolleranza superiore larghezza di taglio
CWX	Larghezza di taglio massima
CXSC	Codice tipo di uscita refrigerante
CZC	Codice misura di connessione
CZC ^{MS}	Codice misura collegamento lato macchina
CZC ^{WS}	Codice misura collegamento lato pezzo
D1	Diametro del foro di fissaggio
DAH	Diametro del foro di accesso
DAXIN	Diametro minimo interno della scanalatura assiale
DAXN	Diametro minimo esterno della scanalatura assiale

DAXX	Diametro massimo esterno della scanalatura assiale
DBC	Diametro del cerchio fori per bulloni
DC	Diametro di taglio
DCB	Diametro del foro di collegamento
DCBN	Diametro minimo interno di collegamento
DCBX	Diametro massimo interno di collegamento
DCF	Diametro di taglio al contatto della faccia
DCIN	Diametro di taglio interno
DCN	Diametro di taglio minimo
DCON	Diametro di collegamento
DCON _{MS}	Diametro di collegamento, lato macchina
DCON _{WS}	Diametro di collegamento, lato pezzo
DCONN _{WS}	Diametro di collegamento minimo, lato pezzo
DCONX _{WS}	Diametro di collegamento massimo, lato pezzo
DCPS	Chip dati diam. 10x4.5 accordi ISO69873
DCSF _{MS}	Diametro superficie di contatto lato macchina
DCSF _{WS}	Diametro superficie di contatto lato pezzo
DCX	Diametro di taglio massimo
DHUB	Diametro del punzone
DIX	Diametro massimo di interferenza con il dispositivo di cambio utensili
DMIN	Diametro minimo del foro
DMM	Diametro stelo
DN	Diametro dello stelo scaricato
DRVCT	Numero dispositivi di trascinamento
DSGN	Versione
EPSR	Angolo incluso dell'inserto
FHA	Angolo d'elica
FLGT	Spessore della flangia
FTDZ	Per dimensione diametro di filettatura
GB	Angolo del petto
H	Altezza dello stelo
HA	Altezza teorica della filettatura
HB	Differenza altezza della filettatura
HBH	Altezza offset del fondo della testina
HC	Altezza effettiva della filettatura
HF	Altezza funzionale
HRY	Punto più basso dal piano di riferimento
HSUP	Altezza del supporto
HTB	Altezza del corpo
HTH	Altezza
IC	Diametro del cerchio inscritto
INSL	Lunghezza inserto
INSUC	Codice di utilizzo dell'inserto
IZC	Codice dimensione inserto
KAPR	Angolo del tagliente utensile
KAPR_EFW	Angolo del tagliente utensile - avanzamento finale
KCH	Smusso angolare
KRINS	Angolo d'attacco principale
KWW	Larghezza sede chiavetta
L	Lunghezza del tagliente
LAMS	Angolo di inclinazione
LB	Lunghezza del corpo
LCF	Lunghezza curvatura truciolo
LCOX	Lunghezza massima di troncatura
LE	Lunghezza effettiva del tagliente
LF	Lunghezza funzionale
LFN	Lunghezza funzionale minima
LH	Lunghezza della testina
LPR	Lunghezza sporgente
LS	Lunghezza stelo
LSC	Lunghezza di bloccaggio
LSCN	Lunghezza minima di bloccaggio
LSCS	Distanza all'inizio del bloccaggio
LSCX	Lunghezza massima di bloccaggio
LSD	Lunghezza stelo "inerte"
LU	Lunghezza utilizzabile (max. raccomandata)
LU_BFW	Lunghezza utile - sfacciatura in tirata
LUX	Massima lunghezza utilizzabile
MHD	Distanza del foro di montaggio
MIID	Identificazione inserto campione
MIID _E	Identificazione inserto campione - posizione finale
MIID _S	Identificazione inserto campione - posizione laterale
MIID _C	Identificazione inserto campione - posizione centrale
MIID _P	Identificazione inserto campione - posizione periferica
MIID _I	Identificazione inserto campione - posizione intermedia
MMCC	Codice per coppia preimpostata
MMCX	Coppia di taglio max.
NOF	Numero di scanalature
NT	Numero di denti
OAH	Altezza globale
OAL	Lunghezza globale
OAW	Larghezza globale
OH	Sporgenza raccomandata
OHN	Sporgenza minima

OHX	Sporgenza massima
ORDCODE	Codice di ordinazione
PCL	Lunghezza cilindrica periferica
PDX	Distanza profilo EX
PDY	Distanza profilo EY
PHD	Diametro del preforo
PHDX	Diametro massimo del preforo
PL	Lunghezza della punta
PNA	Angolo incluso del profilo
PRFRAD	Raggio del profilo
PRSPC	Specifica del profilo
PSIR	Angolo di attacco dell'utensile
PSIRL	Angolo del tagliente principale sinistro
PSIRR	Angolo del tagliente principale destro
PSW	Larghezza scanalatura prelaborata
RADH	Altezza radiale del corpo
RADW	Larghezza radiale del corpo
RAR	Angolo di spoglia inferiore di destra
RE	Raggio di punta
REEQ	Raggio di punta equivalente
REL	Raggio di punta, sinistro
RER	Raggio di punta, destro
RETOLL	Tolleranza inferiore raggio di punta
RETOLU	Tolleranza superiore raggio di punta
RGL	Lunghezza di riaffilatura
RMPX	Massimo angolo di penetrazione
RPMX	Velocità rotazionale massima
S	Spessore dell'inserto
SDL	Lunghezza diametro a gradini
SIG	Angolo di punta
SPTL	Linea di divisione
SSC	Codice misura sede inserto
SSC _E	Codice misura sede inserto - posizione finale
SSC _P	Codice misura sede inserto - posizione periferica
SSC _S	Codice misura sede inserto - posizione laterale
STA	Angolo incluso del gradino
STDNO	Numero standard
SUBSTRATE	Substrato
TCDC	Classe di tolleranza diametro di taglio
TCDCON	Tolleranza sul diametro di collegamento
TCDMM	Tolleranza diametro stelo
TCHA	Tolleranza ottenibile del foro
TCHAL	Tolleranza inferiore del foro ottenibile
TCHAU	Tolleranza superiore del foro ottenibile
TCT	Classe di tolleranza utensile
TCTR	Classe di tolleranza filettatura
TD	Diametro della filettatura
TDZ	Misura del diametro della filettatura
TFLA	Lunghezza flottante del maschio in avanti
TFLB	Lunghezza flottante del maschio indietro
TG	Gradiente conico
THBTP	Proprietà conicità posteriore della filettatura
THCA	Angolo di correzione elica della filettatura
THCHT	Tipo smusso della filettatura
THFT	Tipo forma della filettatura
THFTS	Serie standard forma filettatura
THL	Lunghezza filettatura
THUB	Spessore mozzo
TP	Passo filettatura
TPI	Filetti per pollice
TPIN	Filetti per pollice minimi
TPIX	Filetti per pollice massimi
TPN	Passo minimo di filettatura
TPT	Tipo profilo della filettatura
TPX	Passo massimo di filettatura
TRMAX	Gamma di maschiatura max
TQ	Coppia
TSYC	Codice tipo di utensile
TTP	Tipo di filettatura
ULDR	Rapporto lunghezza-diametro utilizzabile
VCX	Velocità di taglio massima
W1	Larghezza inserto
WB	Larghezza del corpo
WF	Larghezza funzionale
WFCIRP	Larghezza al punto di riferimento dell'articolo da taglio
WSC	Larghezza di bloccaggio
WT	Peso dell'articolo
ZADJ	Numero di inserti regolabili
ZEFF	Numero di taglienti effettivi sulla faccia
ZEFP	Numero di taglienti periferici effettivi (ZEFP)
ZWX	Numero massimo di inserti raschianti

CNSC

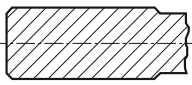
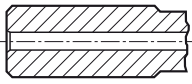
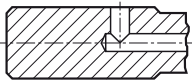
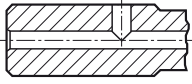
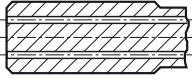
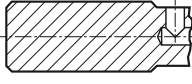
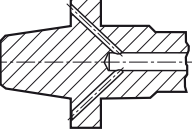
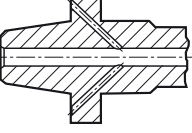
Codice tipo con ingresso refrigerante

Codice	Descrizione	Immagine
0	Senza refrigerante	
1	Entrata assiale concentrica	
2	Entrata radiale	
3	Entrata assiale concentrica e radiale	
4	Entrata assiale concentrica su cerchio	
5	Entrata radiale prima dell'adattatore	
6	Decentrata su flangia	
7	Decentrata su flangia e assiale	
8	Decentrata sulle scanalature dello stelo	

CXSC

Codice tipo di uscita refrigerante

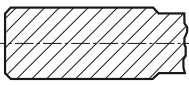
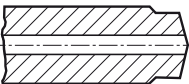
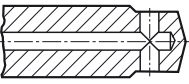
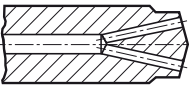
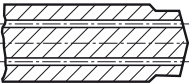
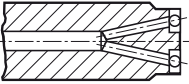
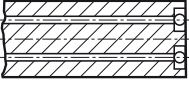
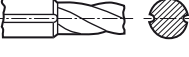
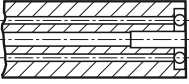
Codice	Descrizione	Immagine
0	Senza uscita refrigerante	
1	Uscita assiale concentrica	
2	Uscita radiale	
3	Uscita assiale inclinata	
4	Assiale concentrica su cerchio	
5	Uscita assiale inclinata con ugello, regolabile	
6	Uscita decentrata con ugello, regolabile	
7	Decentrata sulle scanalature dello stelo	
8	Assiale o decentrata con ugello, regolabile	

Ricondizionamento

Offriamo di più del tradizionale servizio di "riaffilatura". Con il nostro servizio di ricondizionamento, garantiamo le stesse prestazioni iniziali, per ridurre il costo per applicazione.

La nostra offerta



100%

Affidabilità

I nostri specialisti sono a vostra disposizione per offrirvi supporto e know-how.



x3

Prestazioni originali

La qualità dell'utensile originale è garantita - fino a tre volte.



50%

Risparmi

Con il ricondizionamento, è possibile ridurre il costo degli utensili fino al 50%.

Prodotti coperti dal servizio



Foratura



Fresatura



Alesatura



Come indicato dal simbolo del ricondizionamento sulle pagine dedicate alle famiglie di prodotti.

Informazioni aggiuntive



Contenitore per il ricondizionamento

Il contenitore può essere ordinato in due misure -
- Piccolo (300 x 200 x 138 mm)
Numero articolo: 6949557

- Medio (400 x 300 x 138 mm)
Numero articolo: 6949558

Tutti i tipi di utensili Sandvik Coromant possono essere spediti nello stesso contenitore.

Servizio di ricondizionamento

- Prima del ricondizionamento, gli utensili vengono ispezionati per determinare se possono essere ricondizionati. Gli utensili non ricondizionabili verranno restituiti

- Ogni intervento di ricondizionamento viene registrato attraverso una marcatura laser sullo stelo dell'utensile

- Gli utensili vengono restituiti nella confezione originale

Che succede ai vostri utensili?

- Ripristino completo della geometria

- Riduzione della lunghezza della punta

- Riduzione del diametro e della lunghezza delle frese a candela (il diametro minimo è di circa 0.9xDc)

- Mantenimento della tolleranza sul diametro degli alesatori

Per i prezzi, contattate il vostro Tecnico di Vendita Sandvik Coromant di riferimento.

Informazioni per la sicurezza in relazione all'affilatura del metallo duro

Composizione del materiale

La maggior parte dei prodotti di metallo duro contengono carburo di tungsteno e cobalto. Altre sostanze possono essere: carburo di titanio, carburo di tantalio, carburo di niobio, carburo di cromo, carburo di molibdeno o carburo di vanadio. Alcune qualità contengono carbonitruro di titanio e/o nichel.

Rischi di esposizione

L'affilatura o il "riscaldamento" di un semilavorato o di un prodotto di metallo duro produce polvere o esalazioni di sostanze pericolose che possono essere inalate, ingerite, oppure venire a contatto con l'epidermide o gli occhi.

Tossicità acuta

La polvere è tossica per inalazione. L'inalazione può causare irritazioni e infiammazioni alle vie respiratorie. Una tossicità acuta per inalazione, notevolmente più elevata del solo cobalto, è stata riportata durante l'inalazione contemporanea di cobalto e carburo di tungsteno.

Il contatto con la pelle può causare irritazioni e rash cutanei. In persone particolarmente sensibili possono manifestarsi reazioni allergiche.

Tossicità cronica

Ripetute inalazioni di gas contenenti cobalto possono causare occlusioni alle vie respiratorie.

L'inalazione prolungata di concentrazioni maggiori può causare fibrosi o cancro ai polmoni. Studi epidemiologici segnalano che, in passato, i lavoratori esposti ad elevate concentrazioni di carburo di tungsteno/cobalto correvano un rischio maggiore di sviluppare cancro al polmone.

Il cobalto ed il nichel sono due potenti sensibilizzatori della pelle. Contatti ripetuti o prolungati possono causare irritazione e sensibilizzazione.

Segnalazioni di rischio

Tossico: pericolo di gravi danni alla salute in caso di esposizione prolungata per inalazione.

Tossico per inalazione.

Evidenza limitata di un effetto cancerogeno.

Può provocare sensibilizzazione per inalazione e a contatto con l'epidermide.

Misure preventive

Evitare la formazione e l'inalazione di polvere. Usare un impianto di ventilazione che sia adatto a limitare l'esposizione al personale ben al di sotto dei limiti consentiti a livello nazionale.

Se l'impianto di ventilazione non è disponibile o adeguato, usare respiratori approvati, a livello nazionale, per lo scopo.

Indossare occhiali di protezione o occhiali con schermi laterali, quando è necessario.

Evitare il contatto ripetuto con l'epidermide. Indossare guanti adatti. Lavarsi accuratamente dopo la manipolazione.

Usare vestiario di protezione adatto. Usare indumenti lavabili e riutilizzabili, se richiesto.

Non mangiare, bere o fumare nell'area di lavoro. Lavarsi accuratamente prima di mangiare, bere o fumare.



Per il rispetto dell'ambiente!

Informatevi subito sul Sistema di Riciclo Coromant (CRC)!

Il Sistema di Riciclo Coromant (CRC) è un servizio completo che Sandvik Coromant offre a tutti i suoi clienti per la raccolta degli inserti di metallo duro usurati e degli utensili integrali di metallo duro.

In considerazione del crescente consumo di materie prime "non rinnovabili", la gestione economica delle risorse in via di estinzione diventa un dovere di tutti i produttori.

Sandvik Coromant svolge la sua parte offrendo la possibilità di raccogliere inserti di metallo duro e utensili integrali di metallo duro usurati e di riciclarli nel rispetto dell'ambiente.

I vantaggi del Sistema di Riciclo Coromant (CRC) sono:

- Sistema di riciclo su scala mondiale, certificato secondo ISO e OHAS.
- Senza intermediari.
- Semplice procedura di raccolta e trasporto.
- Meno rifiuti, minore contaminazione dell'ambiente.
- Migliore utilizzazione delle risorse.
- Raccolta di inserti anche di altri fabbricanti.



Contattare Sandvik Italia, Divisione Coromant, telefonicamente al numero 02/30.705.1 o via fax al numero 02/30705.580, oppure il nostro Tecnico di Vendita o Rivenditore Autorizzato di zona, per richiedere ulteriori informazioni ed ordinare i contenitori per la raccolta (ogni contenitore contiene fino a 20 Kg.)

Contenitore per la raccolta:

Cassetta di trasporto (in legno compensato) per utensili di metallo duro integrali:

Contenitore di raccolta inserti (in legno compensato):

Codici di ordinazione

91617

92994

92995